

LEGO

CITY

7245



4266175



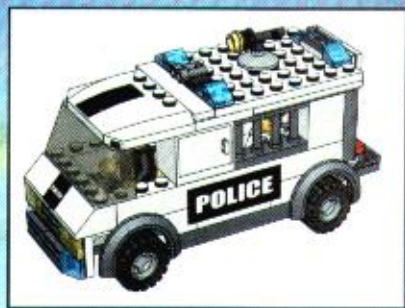

1

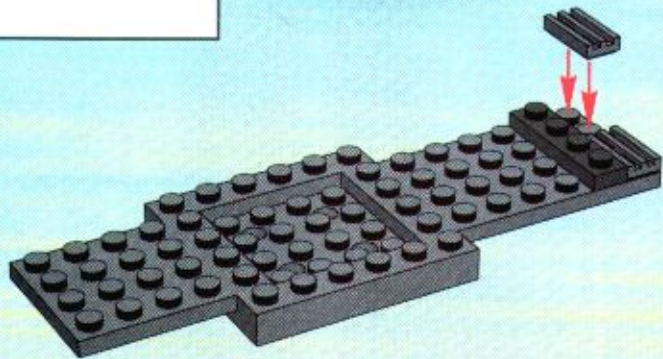

2

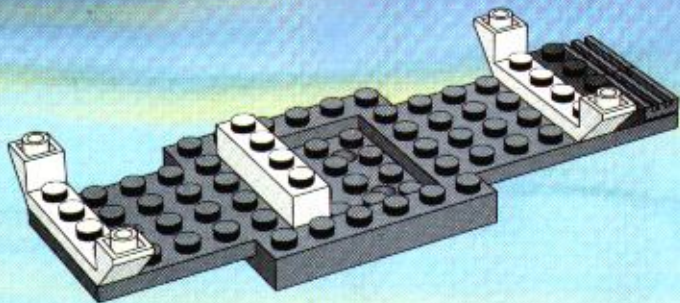

3

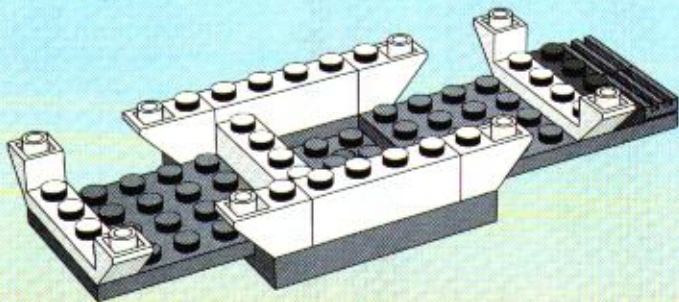

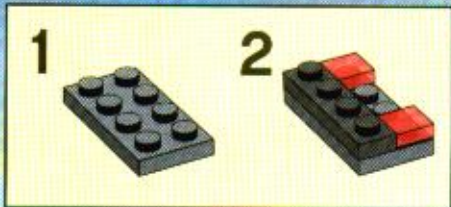

4

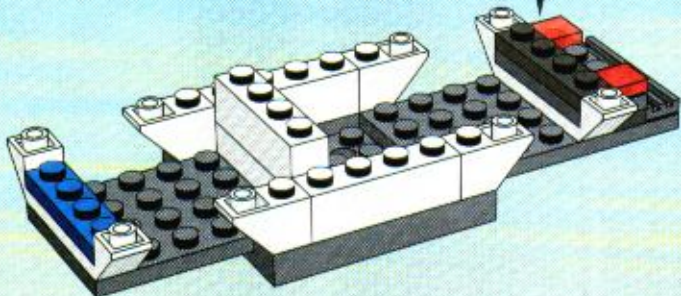

5

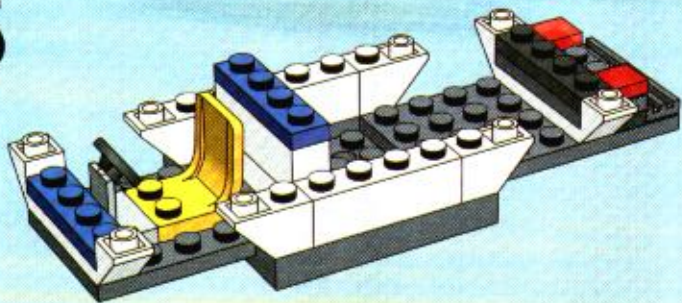

6

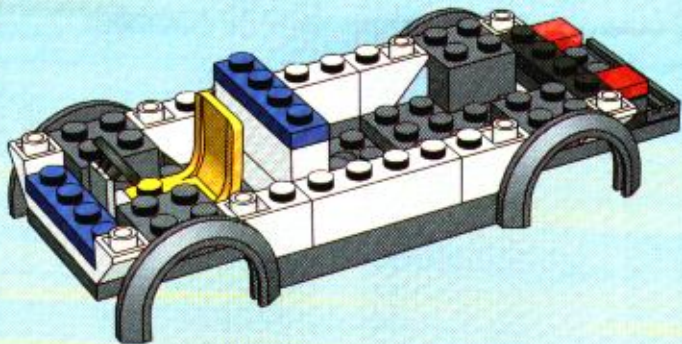

7

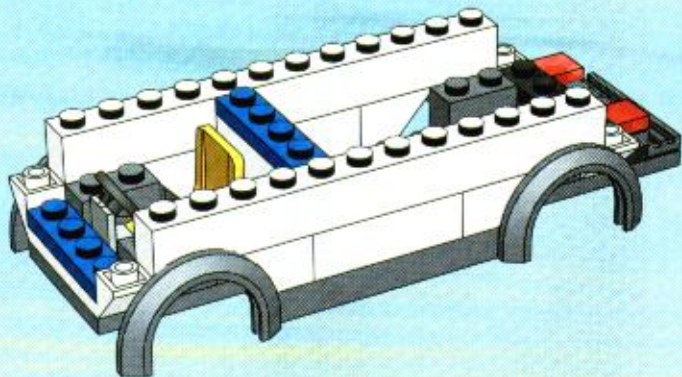

8

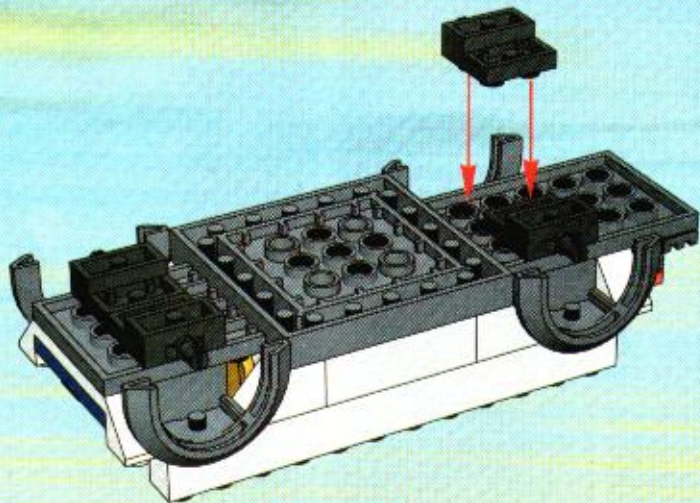

9

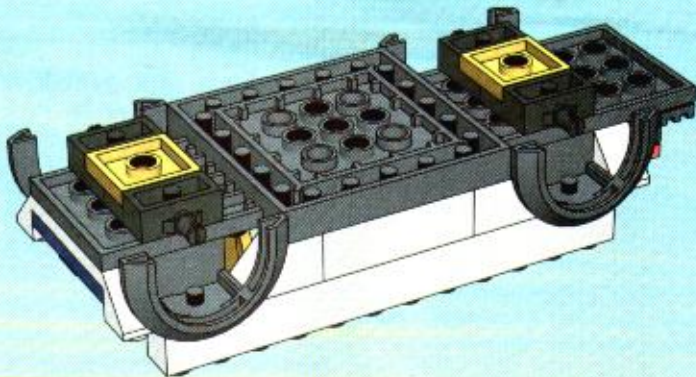

10

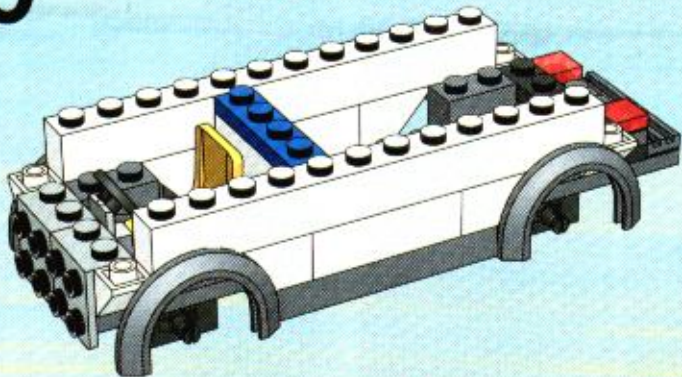

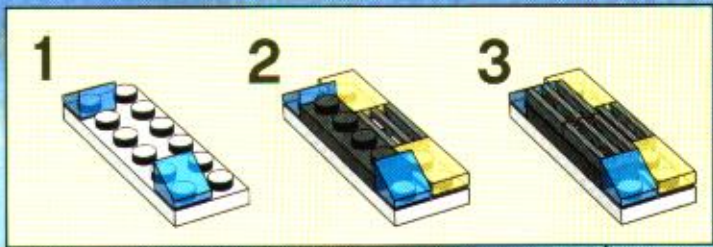

11

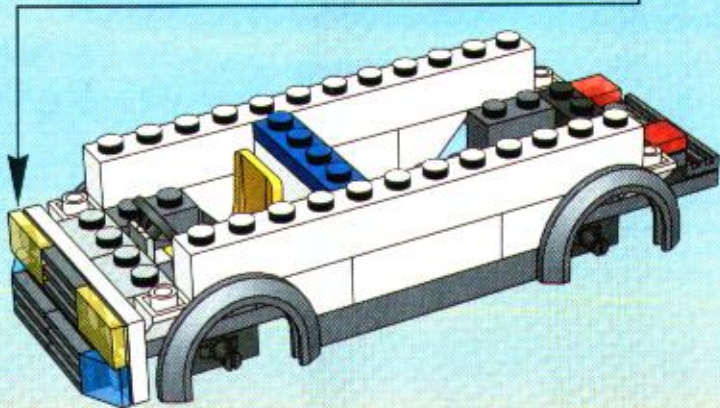

12

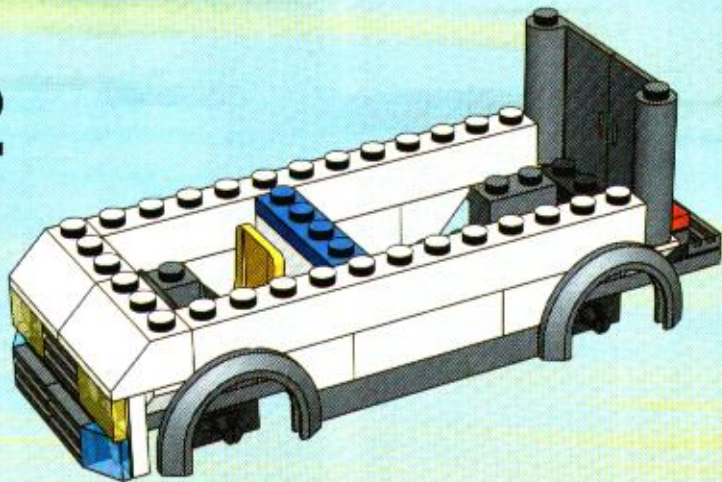

13

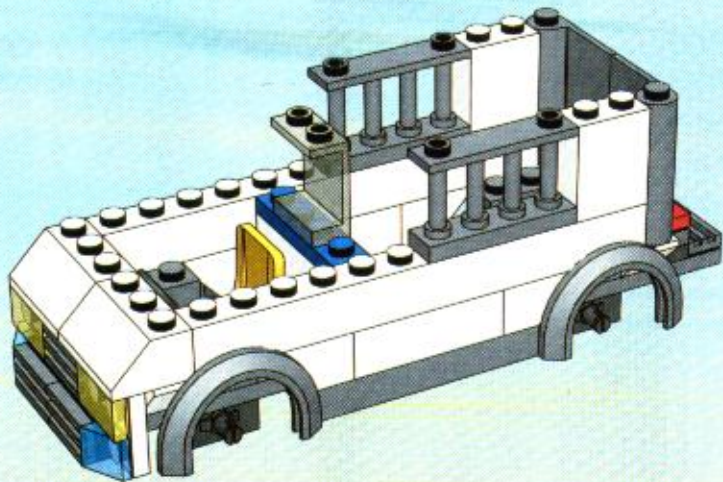

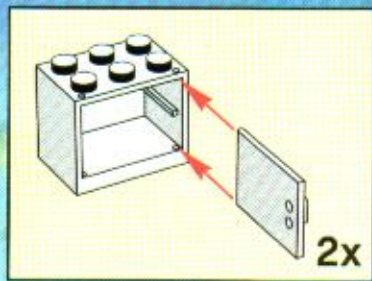

14

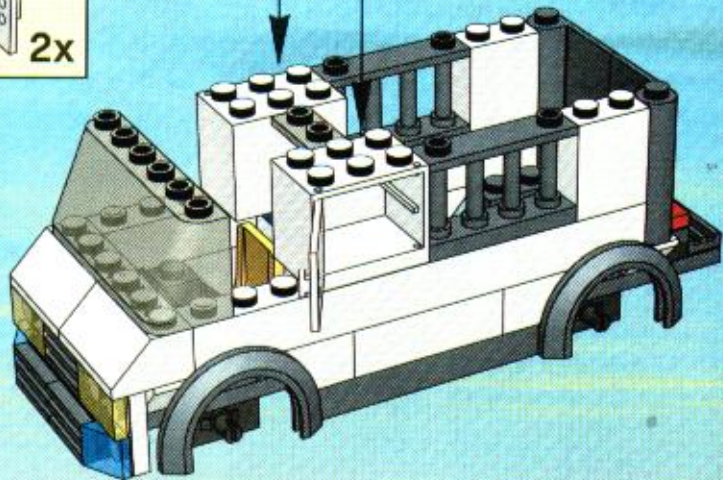

15

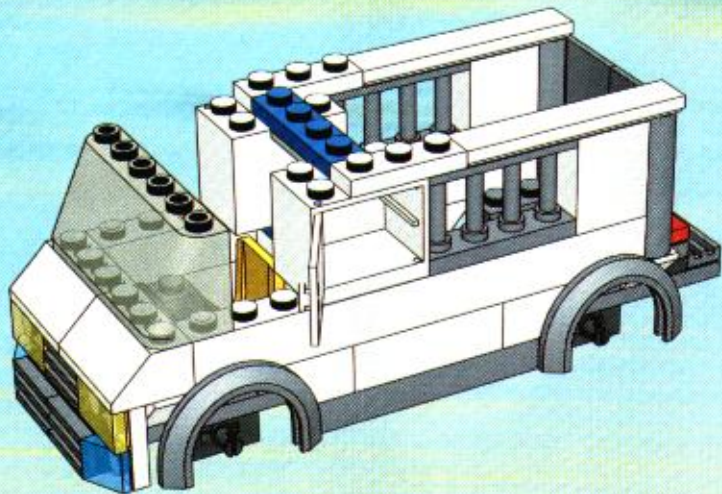

16

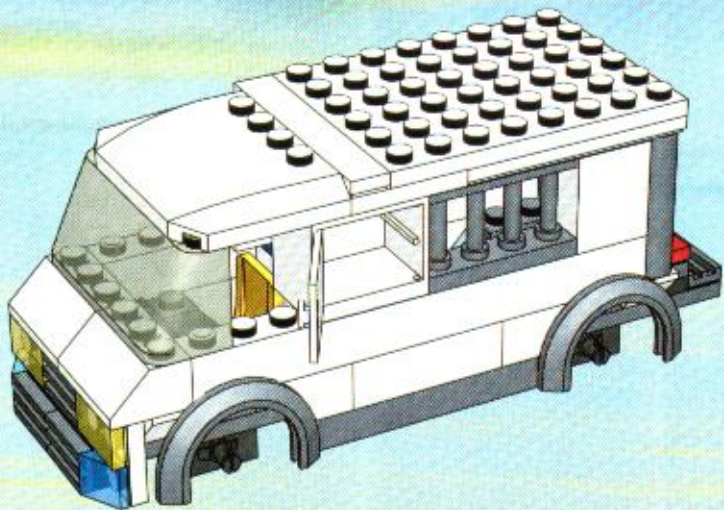

1

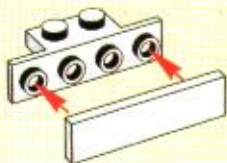

2



17

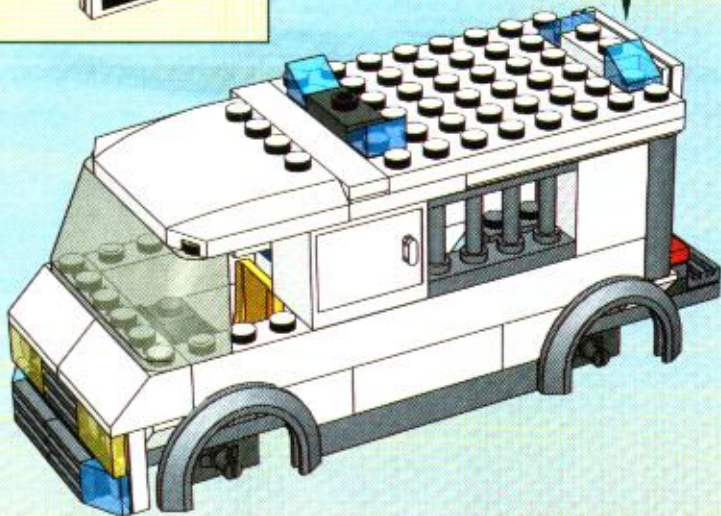

18

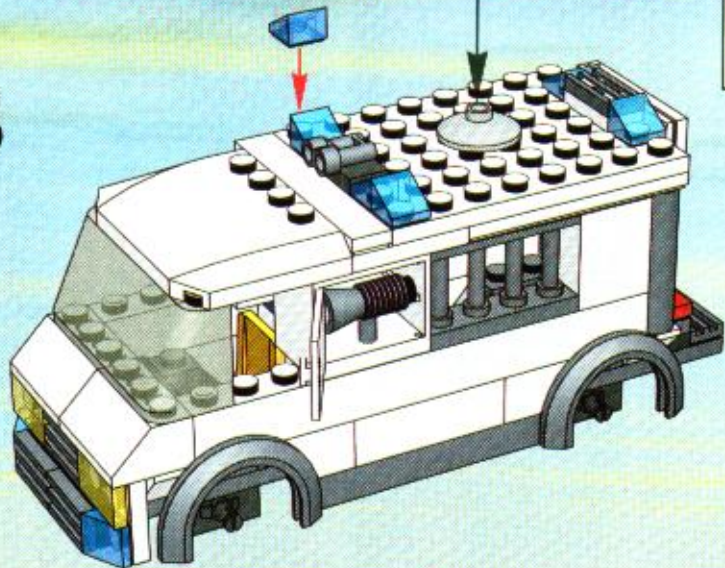

19







7237



7235



7236



7245



7238



7246



7240



7239



7241

Win! Gagne! Gewinne! 当たります



WIN LEGO® PRODUCTS

We would like to know what you think about our new LEGO® product. Log on to the web address below for further instructions.

GAGNE DES PRODUITS LEGO®

Nous aimerions savoir ce que tu penses de ton nouveau produit LEGO®. Tu obtiendras davantage d'informations en visitant le site Internet indiqué ci-dessous.

GEWINNE LEGO® PRODUKTE

Wir sind sehr an deiner Meinung über dein neues LEGO® Produkt interessiert. Gehe einfach zu der unten angegebenen Webadresse - dort findest du weitere Informationen.

抽選でレゴ®製品が当たります

詳しくは、以下のURLアドレスまでアクセスして下さい。

ESTIMADO USUARIO LEGO®

Al contestar algunas preguntas en inglés, francés, alemán o japonés en el sitio www.acnielsen.aim.dk/lego podrás participar en el sorteo de algunos valiosos premios LEGO®.

CARO CONSUMIDOR DA LEGO®

Ao responder a algumas perguntas em Inglês, Francês, Alemão ou Japonês no endereço www.acnielsen.aim.dk/lego irá participar num concurso para ganhar valiosos prémios da LEGO®.

KEDVES IFJÚ LEGO® VÁSÁRLÓ

Ha eliaogat az www.acnielsen.aim.dk/lego honlapra és ott angol, francia, német vagy japán nyelven megválaszolsz néhány kérdést, akkor részt veszel egy versenyben, amelyben értékes LEGO® ajándék nyerhetsz.

www.acnielsen.aim.dk/LEGO

LEGO®, the LEGO logo, the LEGO logo and Technic are trademarks of the LEGO Group. ©2004 The LEGO Group.
LEGO®, el logo de LEGO, el logo de LEGO y el Technic son marcas de la LEGO Group.
LEGO®, el logo de LEGO, el logo de LEGO y el Technic son marcas de la LEGO Group.
LEGO®, el logo de LEGO, el logo de LEGO y el Technic son marcas de la LEGO Group.
LEGO®, el logo de LEGO, el logo de LEGO y el Technic son marcas de la LEGO Group.

POLICE

POLICE

POLICE

POLICE

POLIZEI

POLIZEI

POLIZEI

POLIZEI

52800/4261757 © 2005 LEGO GROUP

1

2

3

4

5

6

7

8

9

1

2

3