

**LEGO**

**CITY**

60277





- 1 Scan the code on the front cover  
Scanne den Code auf der Titelseite  
Scanne le code sur la page de couverture  
Scanner le code sur la page couverture  
Scansiona il codice sulla copertina  
Escanea el código de la portada  
Faz scan do código na frente da capa  
Olvasd be a borítón látható kódot!  
Noskenë kodu uz priekšējā vāka  
扫描封面上的二维码



- 2 Get Instructions PLUS  
Hol dir Instructions PLUS  
Obtiens les instructions PLUS  
Obtenir les Instructions PLUS  
Scarica Instructions PLUS  
Descubre Instructions PLUS  
Obtém Instruções PLUS  
Szerezd be az Instructions PLUS kiegészítőt!  
Sanem "Instructions PLUS"  
获取更多说明

**LEGO.com/apps**

Check for compatibility  
Kompatibilität prüfen  
Vérifier la compatibilité  
Controlla la compatibilità  
Comprueba tu compatibilidad

Verificar a compatibilidade  
Ellenőrizd a kompatibilitást  
Pārbaudīt saderību  
检查兼容性

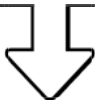

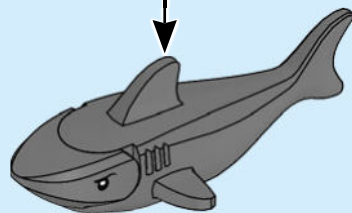
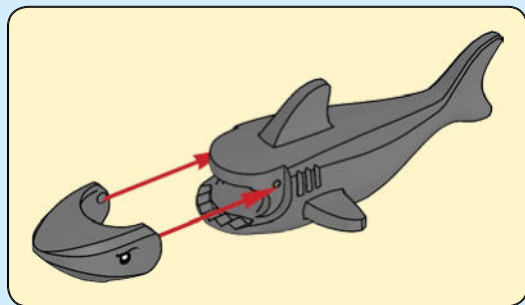

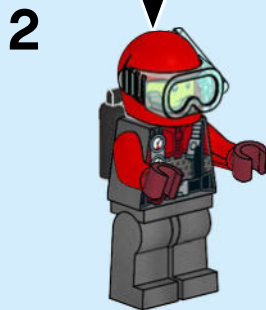
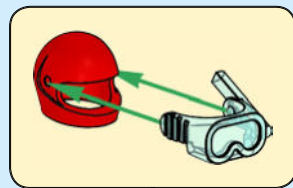
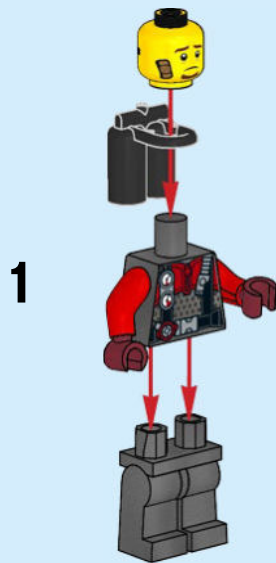

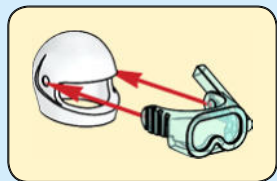
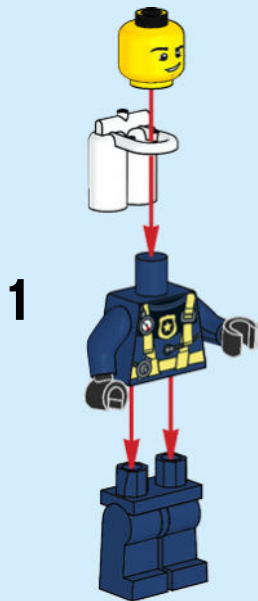



1x

1

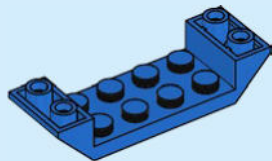

2x

2

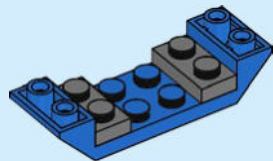



2x

3

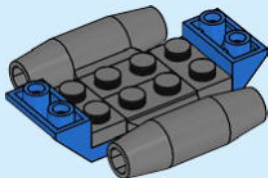

8



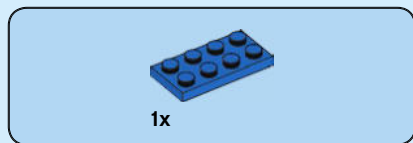

4

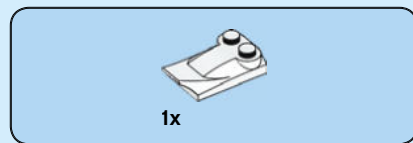
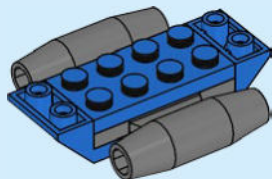

5

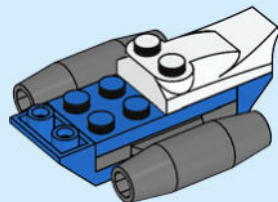



1x

6

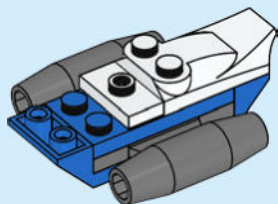



2x

7

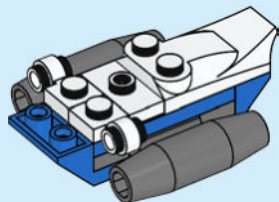

1x

8

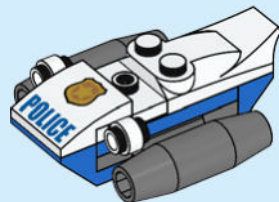



2x

9

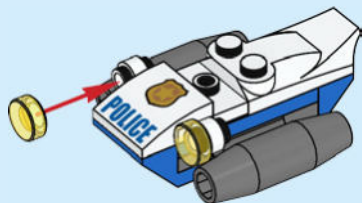



1x



1x

# 10

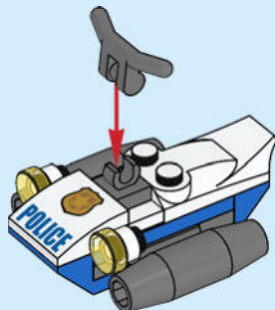

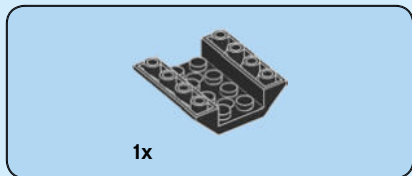
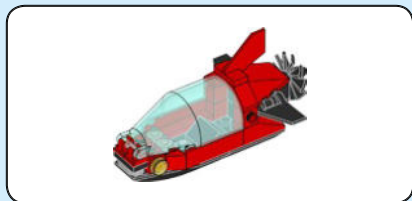

1

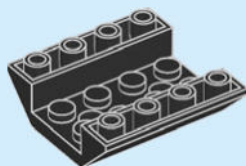

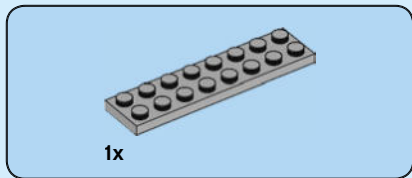

**2**

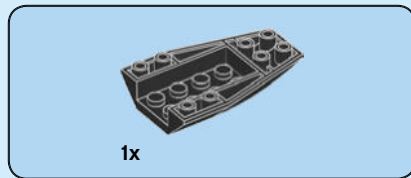
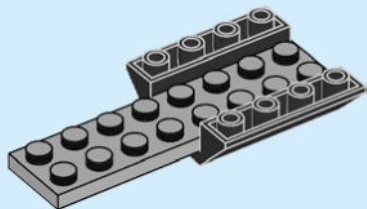

**3**

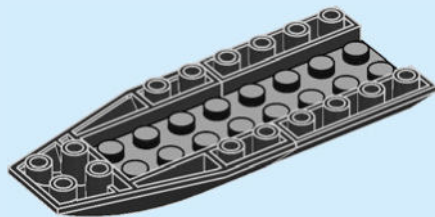

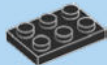

1x

4

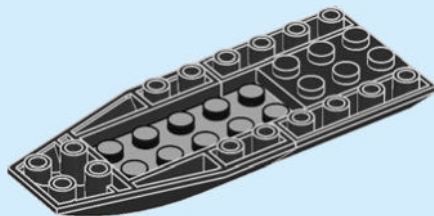



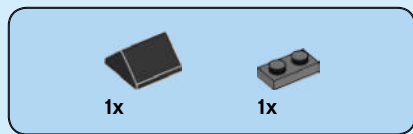

5

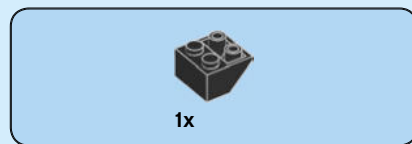
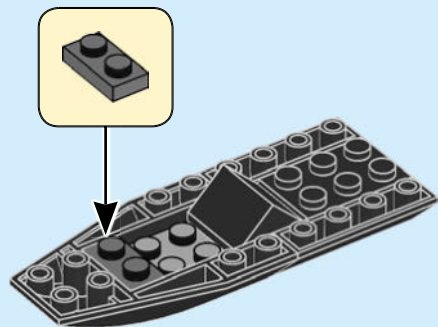

6

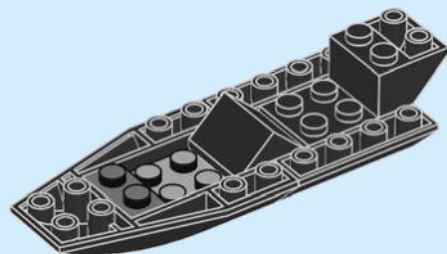



2x

7

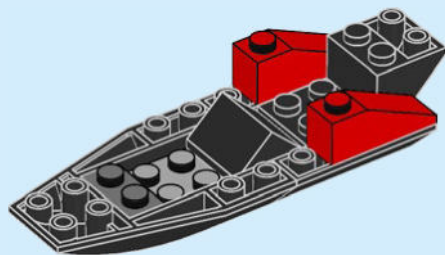



1x

8

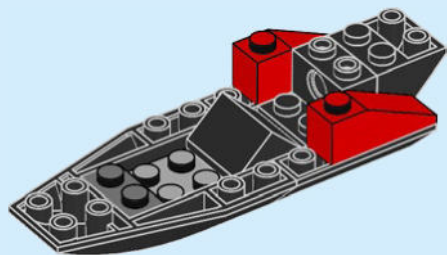

2x

9

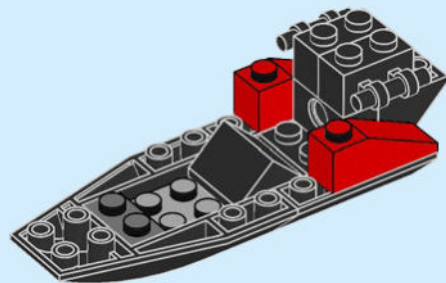

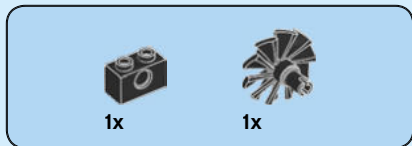

10

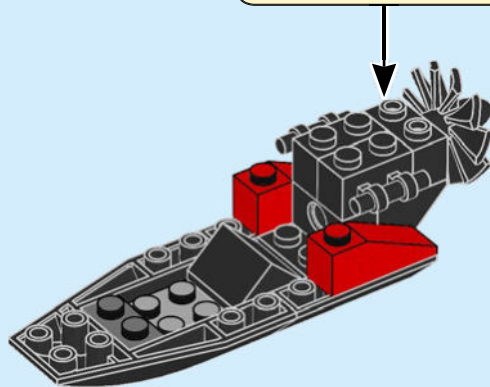
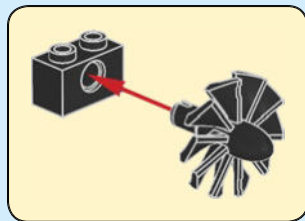



11

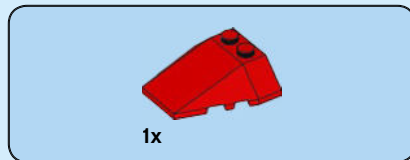
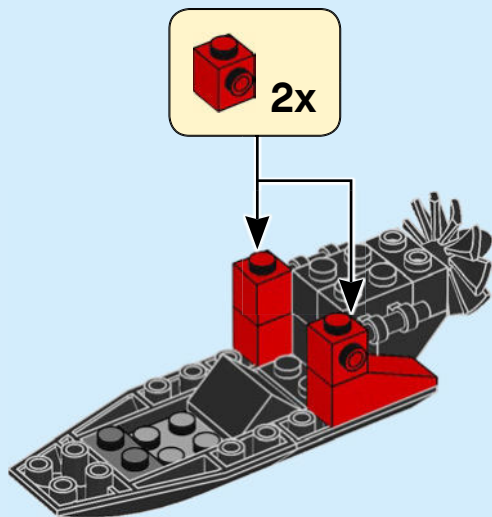

12

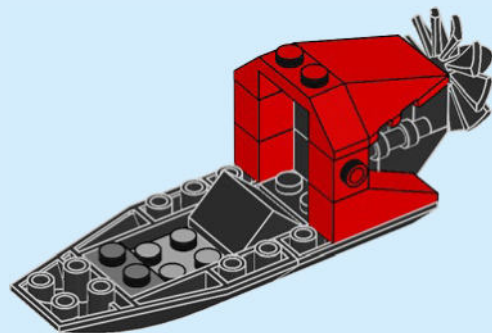

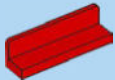

2x

13

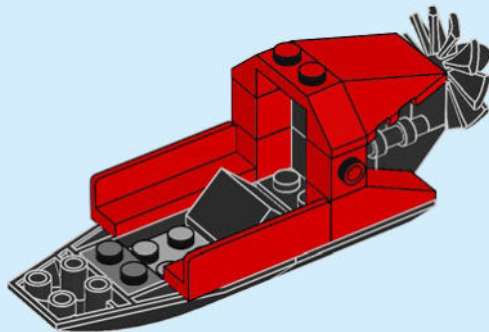



2x



1x

14

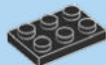
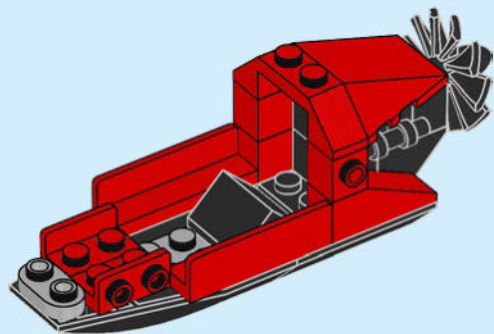

1x

15

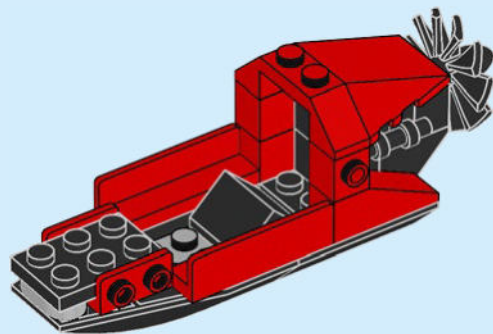



2x



2x

# 16

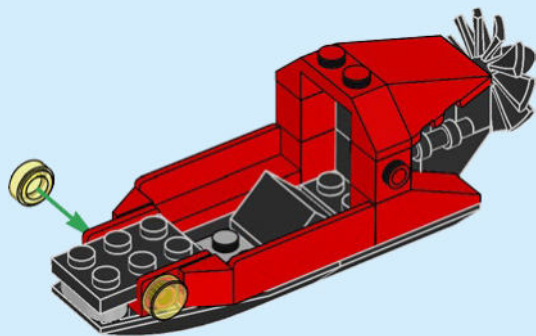





2x

17

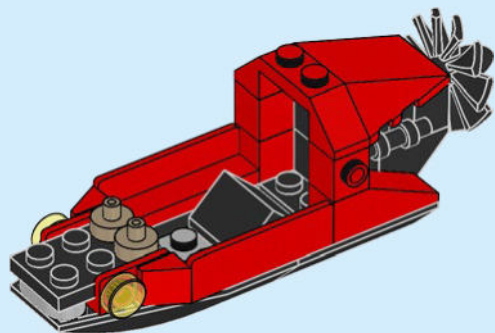

2x

18

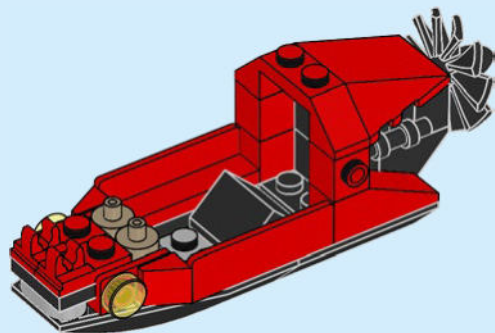



2x

19

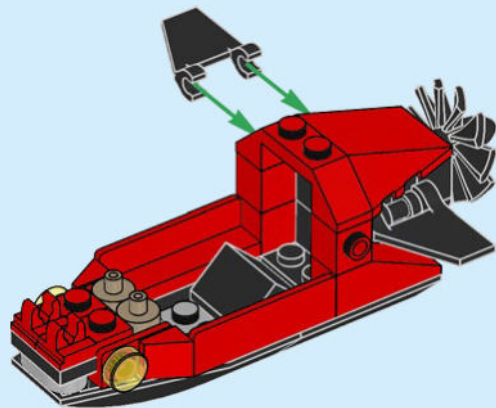

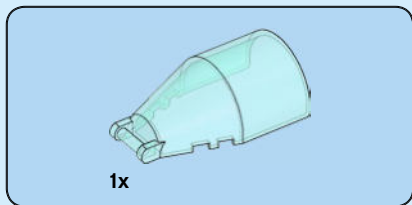

20

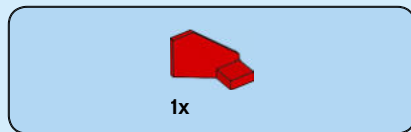
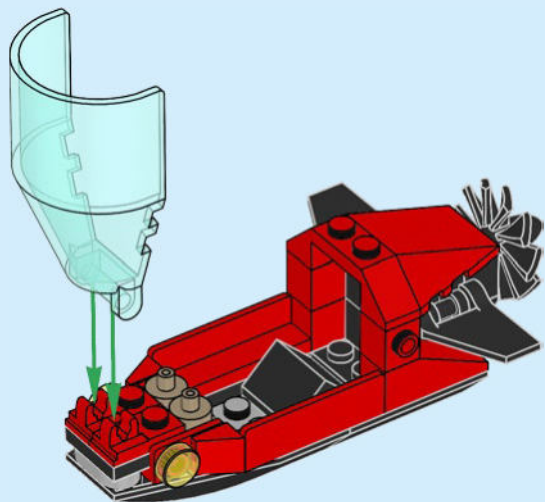

21

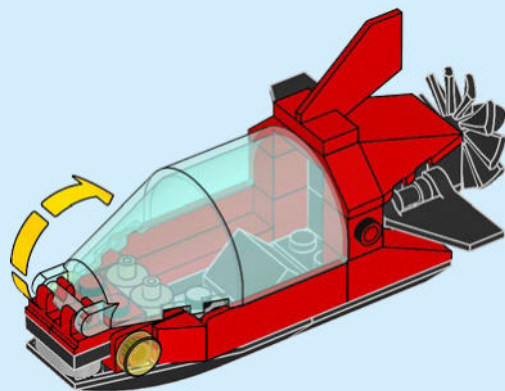

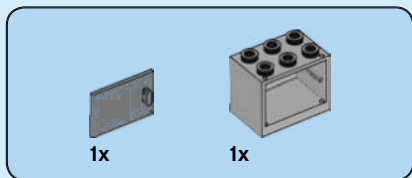
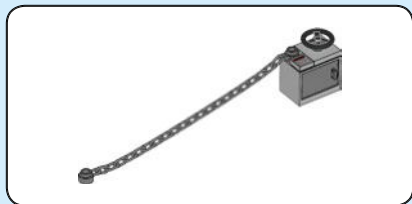

22

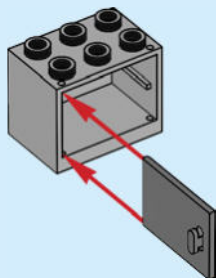

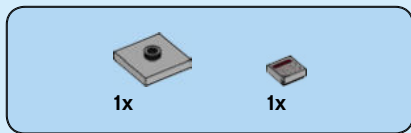

23

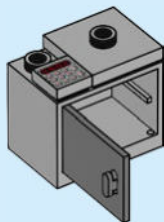

24

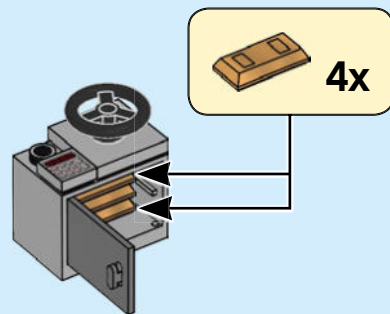

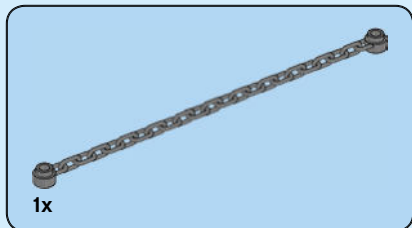

25

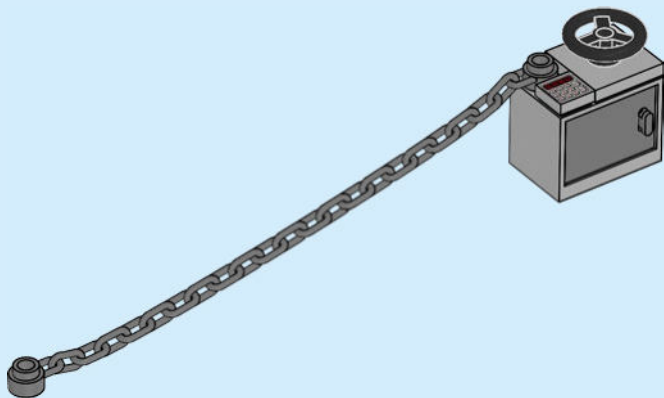

26

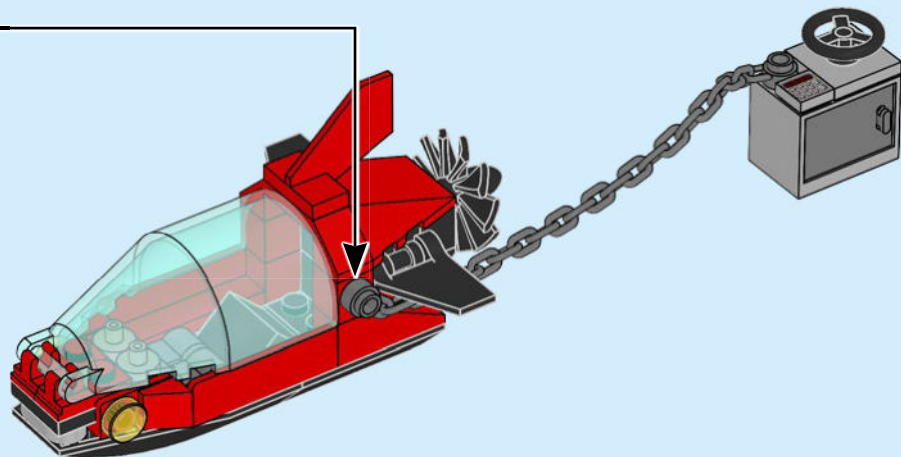







# CITY ADVENTURES

City Abenteuer  
Aventuras en City  
City Aventuras  
City kalandok  
City piedzivojumi  
乐高城市大冒险



VITO

60242



SAM  
GRIZZLED

60243



SNAKE  
RATTLER

60243 • 60276



ROOKY  
PARTNER

60244



FRANKIE  
LUPELLI

60244 • 60277



TOM  
BENNETT

60245



BIG  
BETTY

60245



WHEELER

60246



DAISY  
KABOOM

60246



CLARA  
THE CRIMINAL

60276



GRACIE  
GOODHART

60277



DUKE  
DETAIN

60242 • 60246 • 60276



FREYA  
MCLOUD

60248 • 60280



CLEMMONS

60247 • 60281



BOB

60282



FELDMAN

60282



TREAD  
OCTANE

60258



HARL  
HUBBS

60258 • 60266



SHIRLEY  
KEEPER

60292



MADISON

60292

# CITY

## ADVENTURES

City Abenteuer  
Aventuras en City  
City Aventuras  
City kalandok  
City piedzīvojumi  
乐高城市大冒险

Aus der erfolgreichen TV-Serie!  
Vu dans la série télévisée à succès !  
Dalla divertentissima serie TV!  
¡De la popular serie de la tele!  
Da série de sucesso da TV!  
A népszerű TV-sorozatból!  
No populārā TV seriāla!  
源自热门动画片!



FROM THE HIT  
TV SERIES!



# CITY



60277



60275



60276



CITY

60277



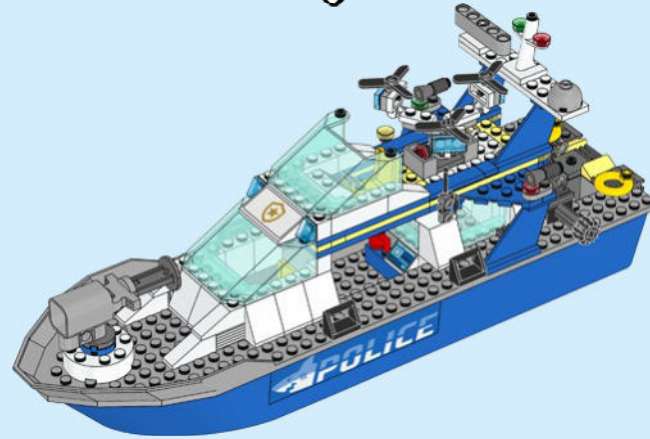
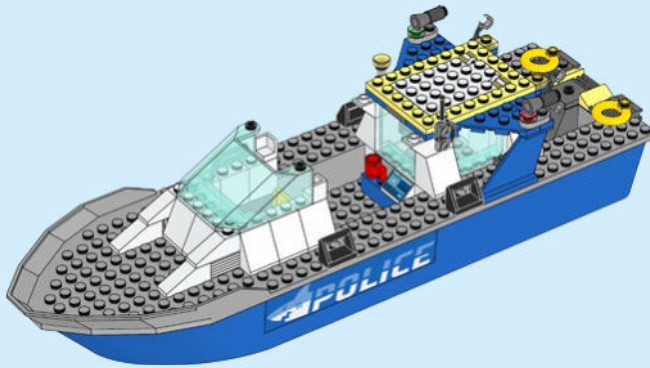

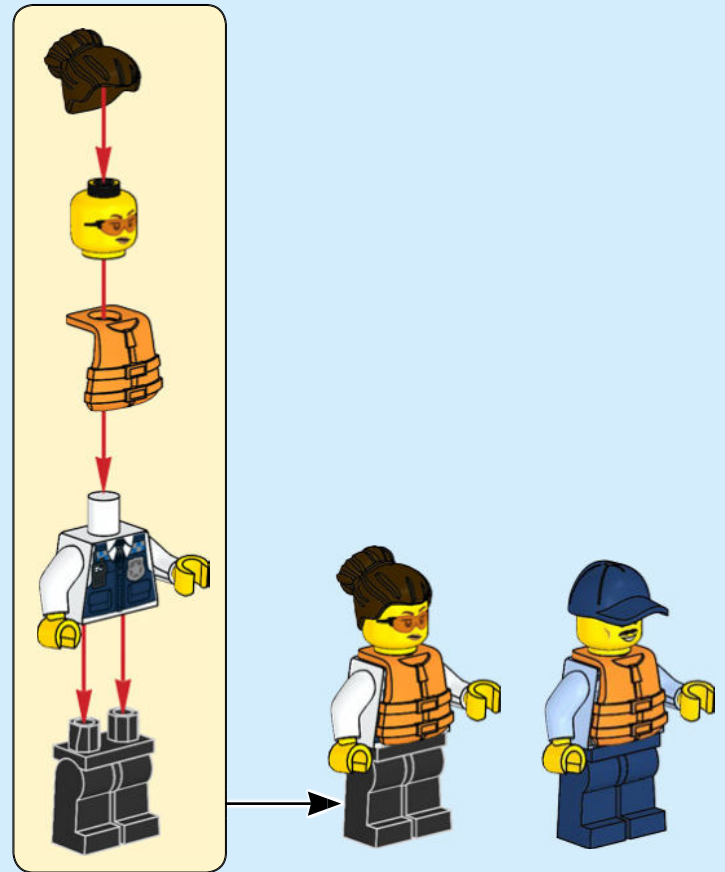
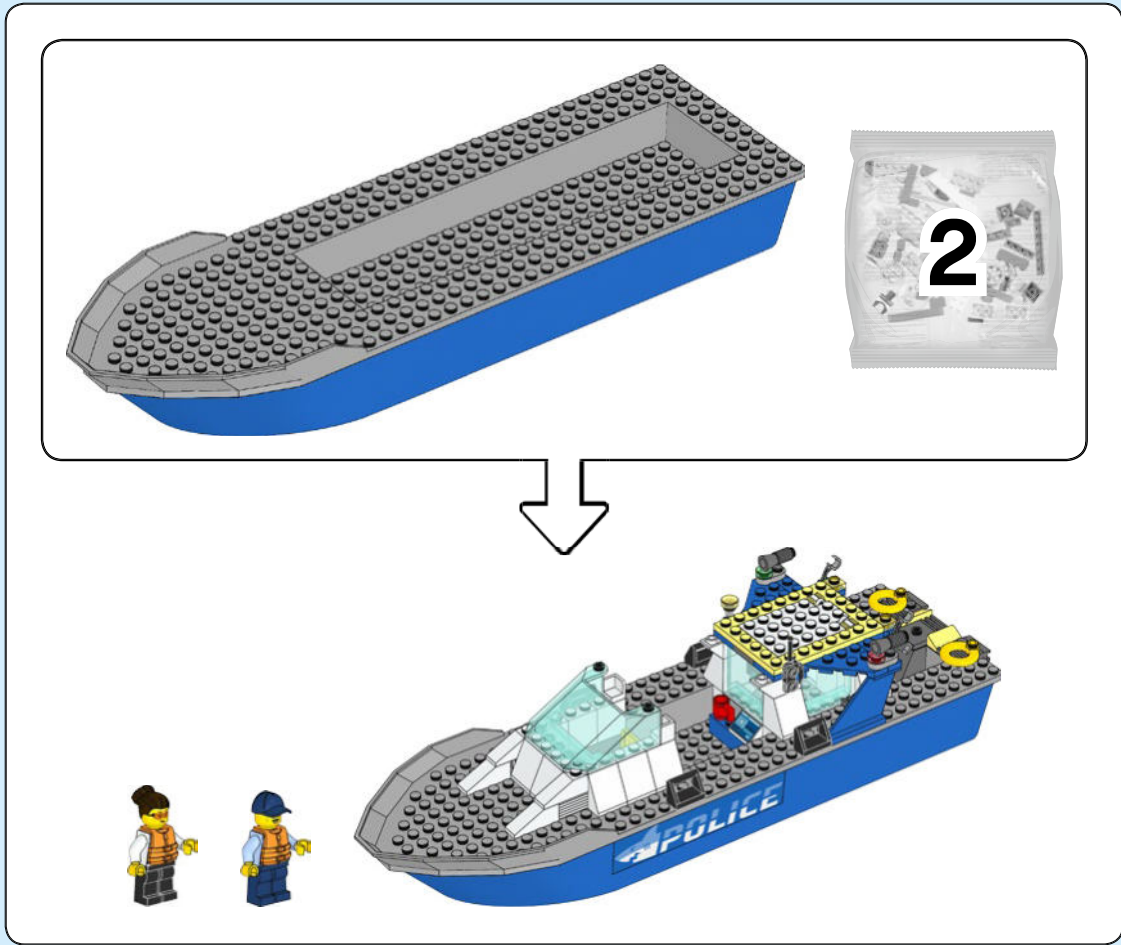

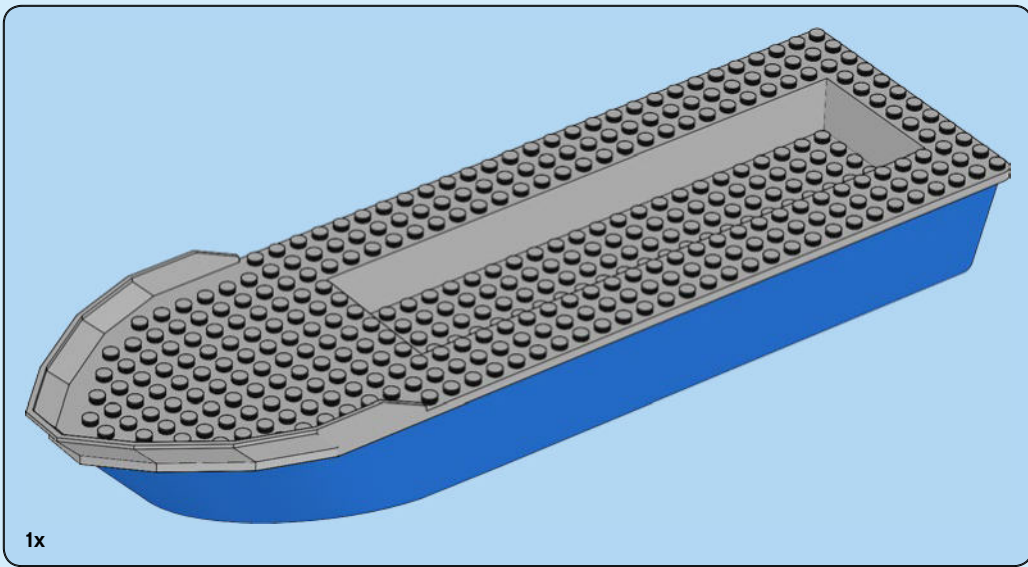

1

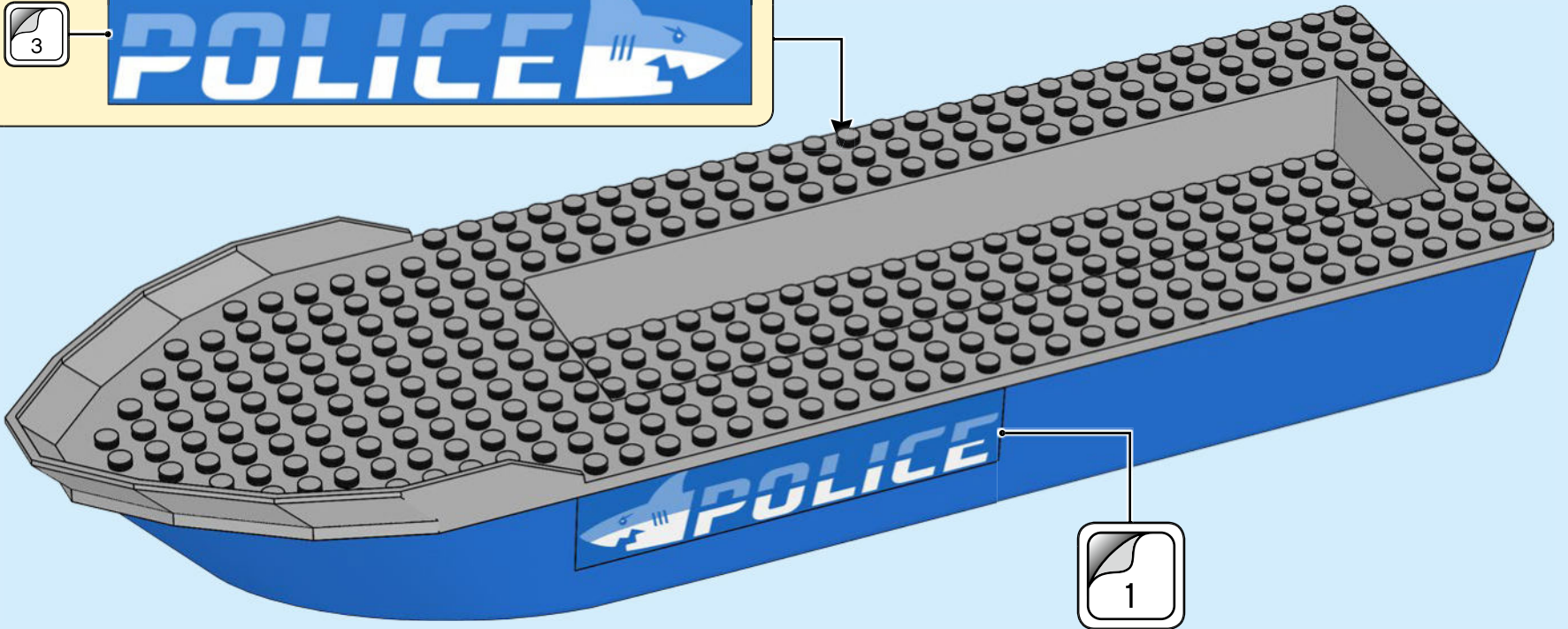



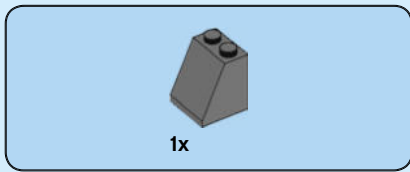

2

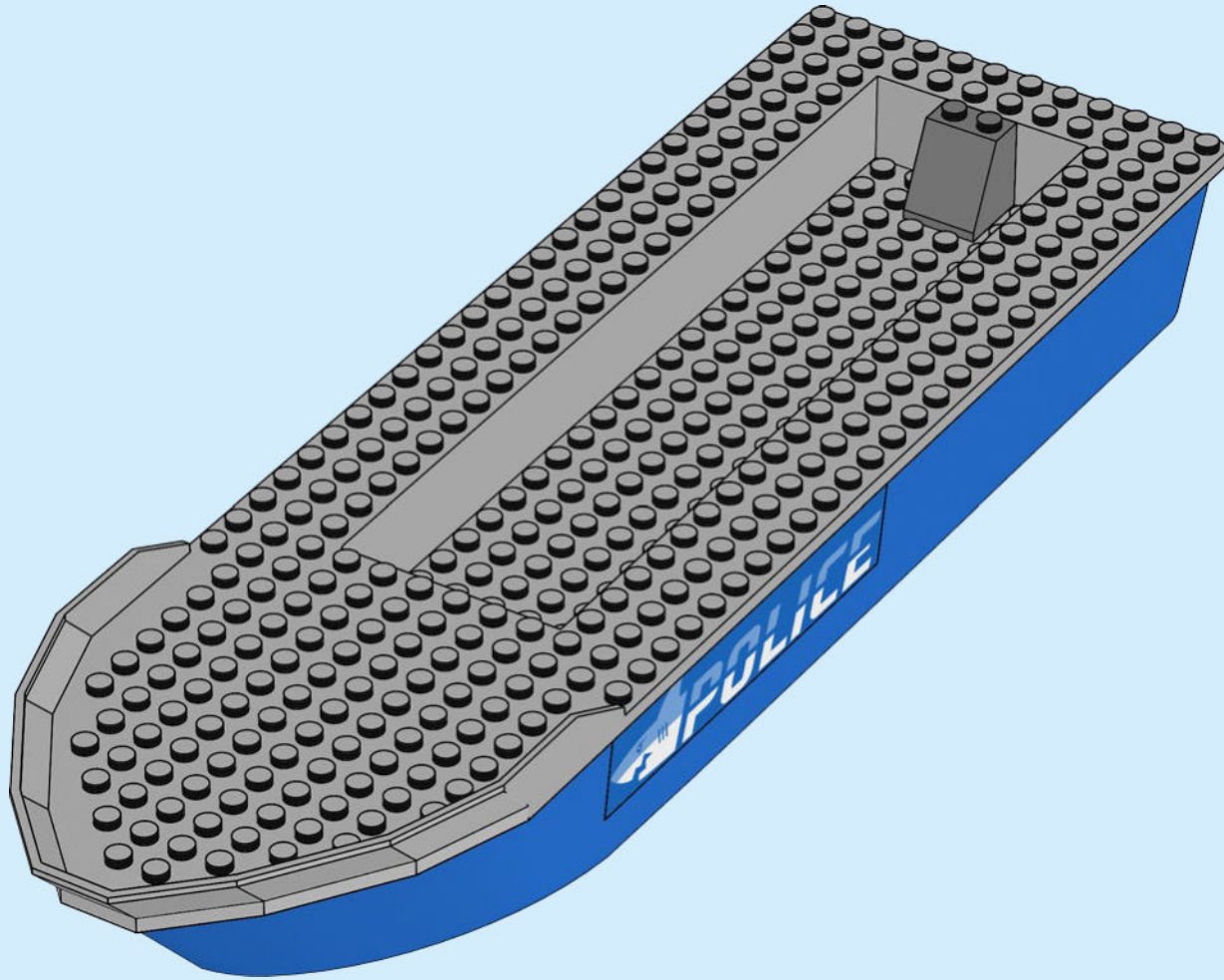

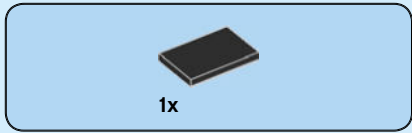

3

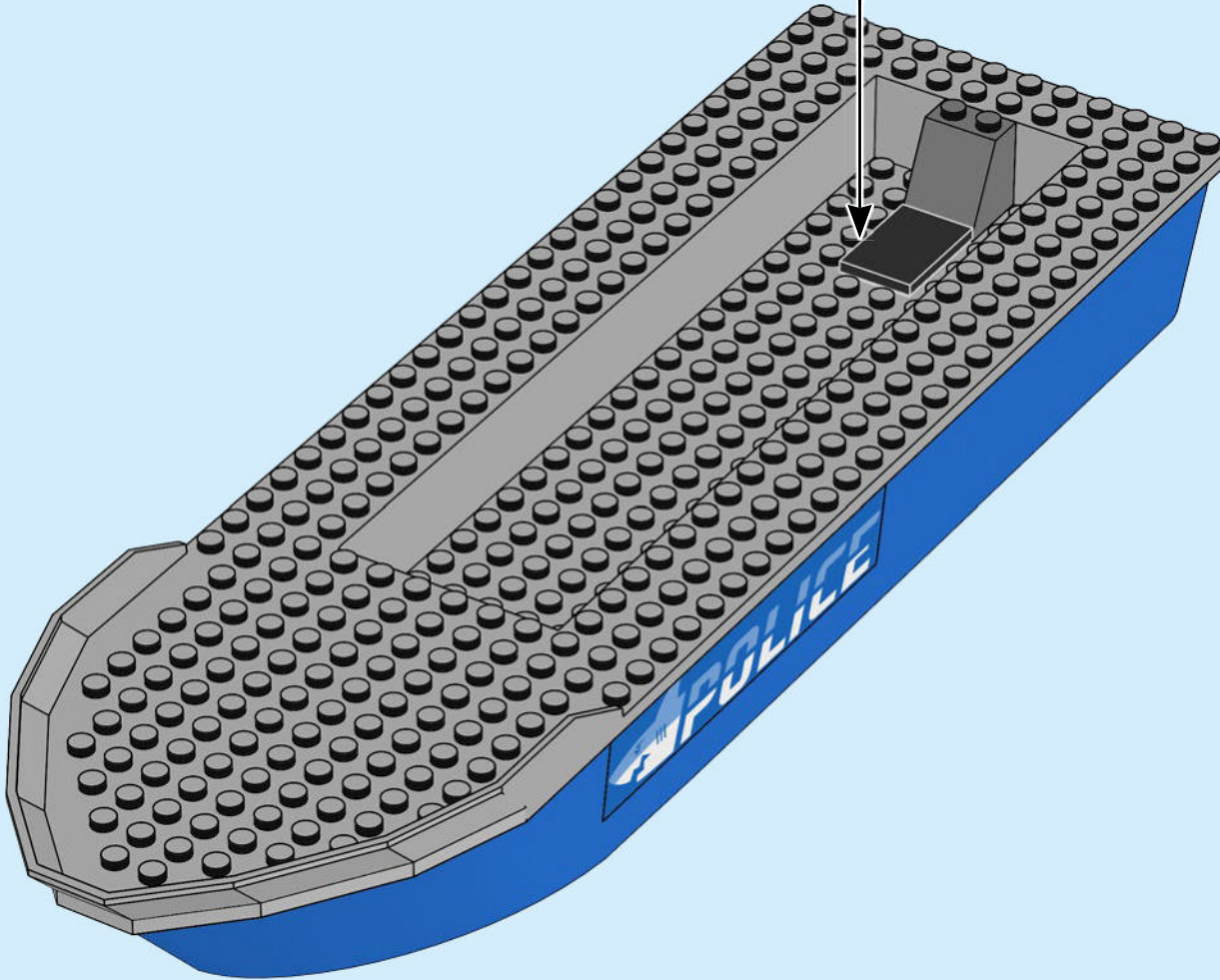
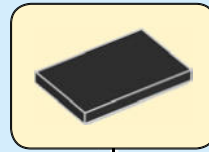

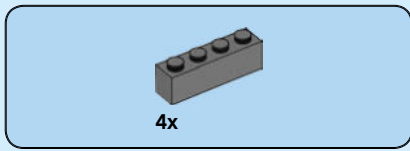

4

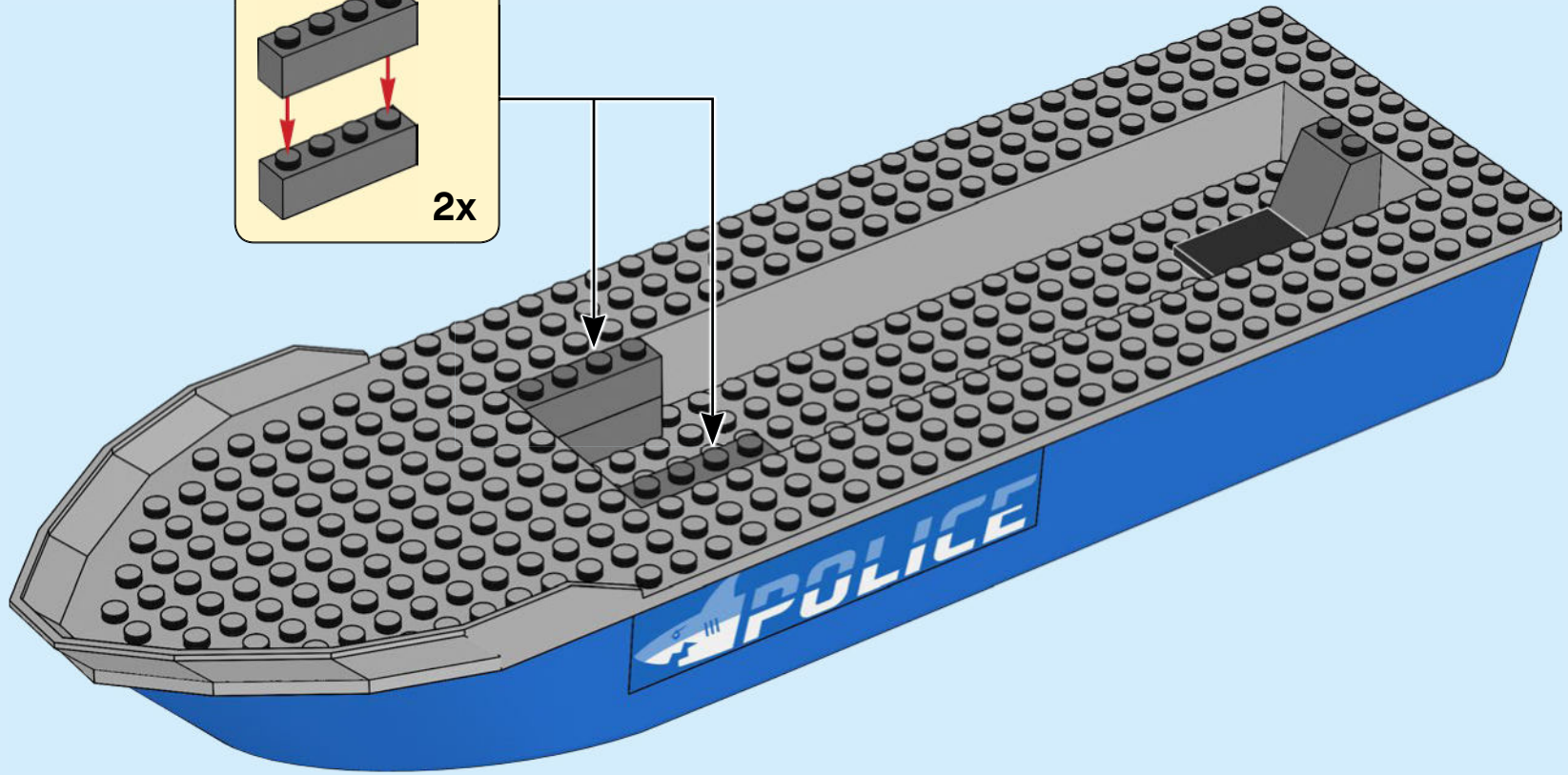
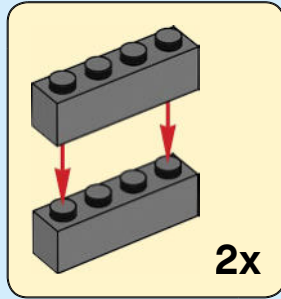

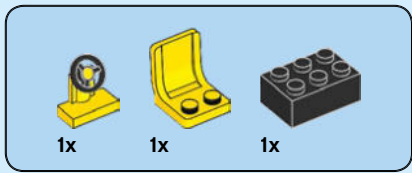

5

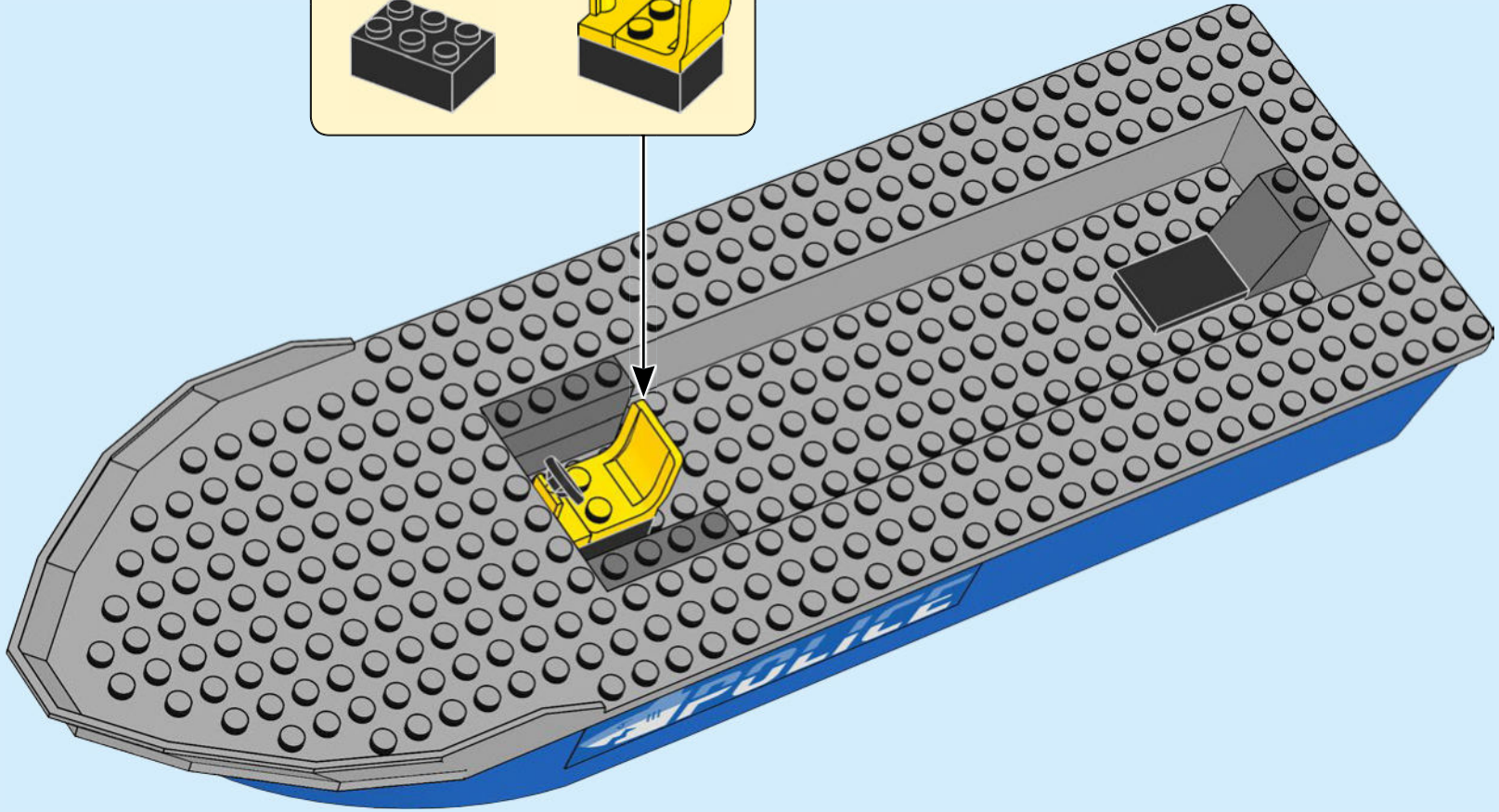
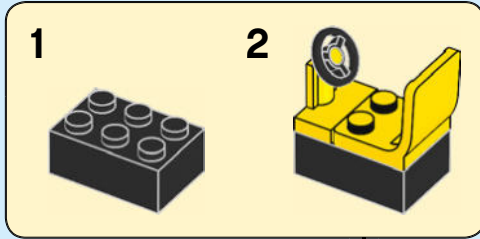

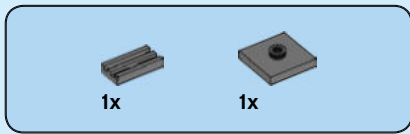

6

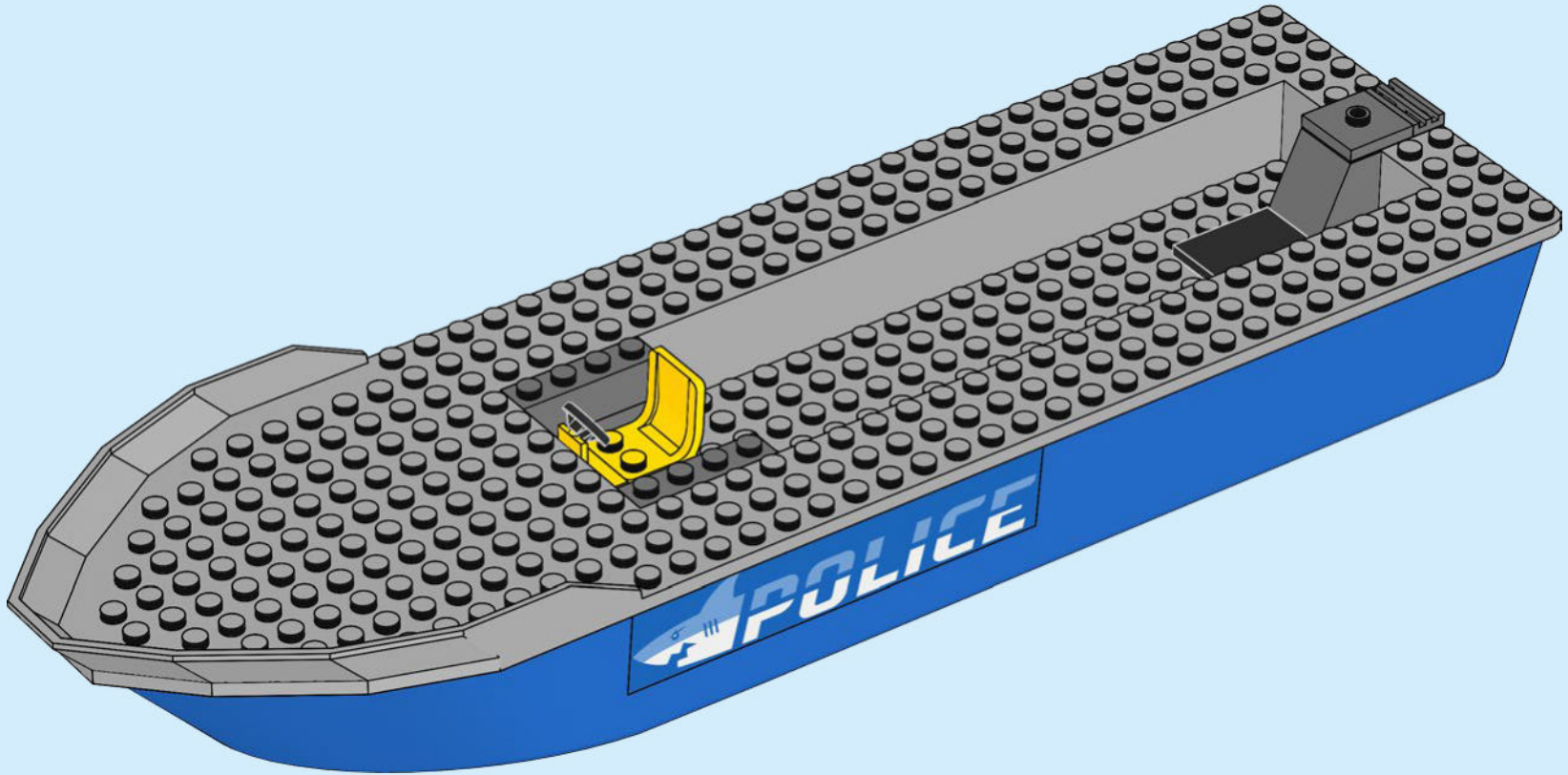



2x

7

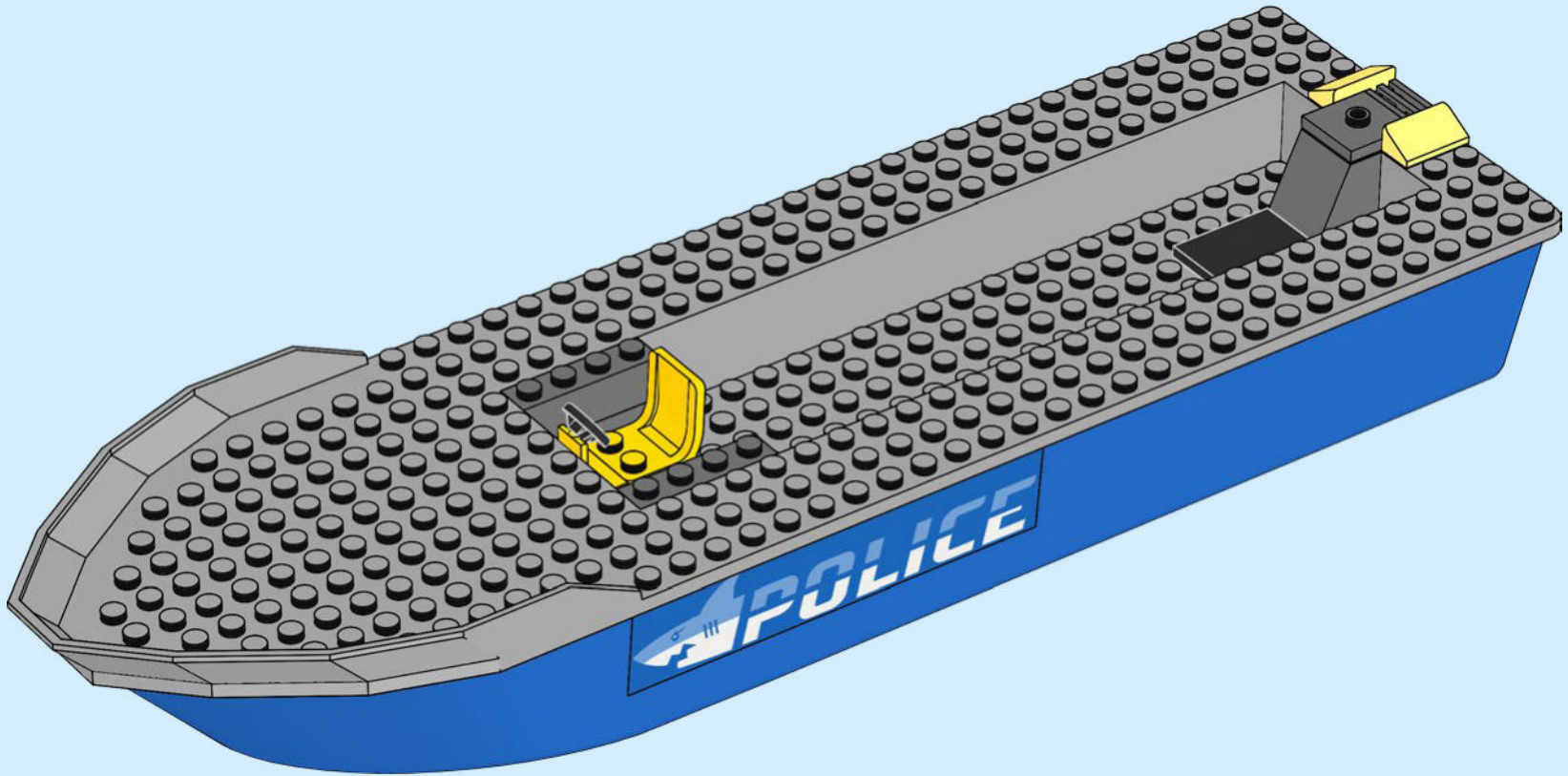

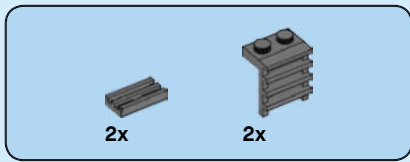

8

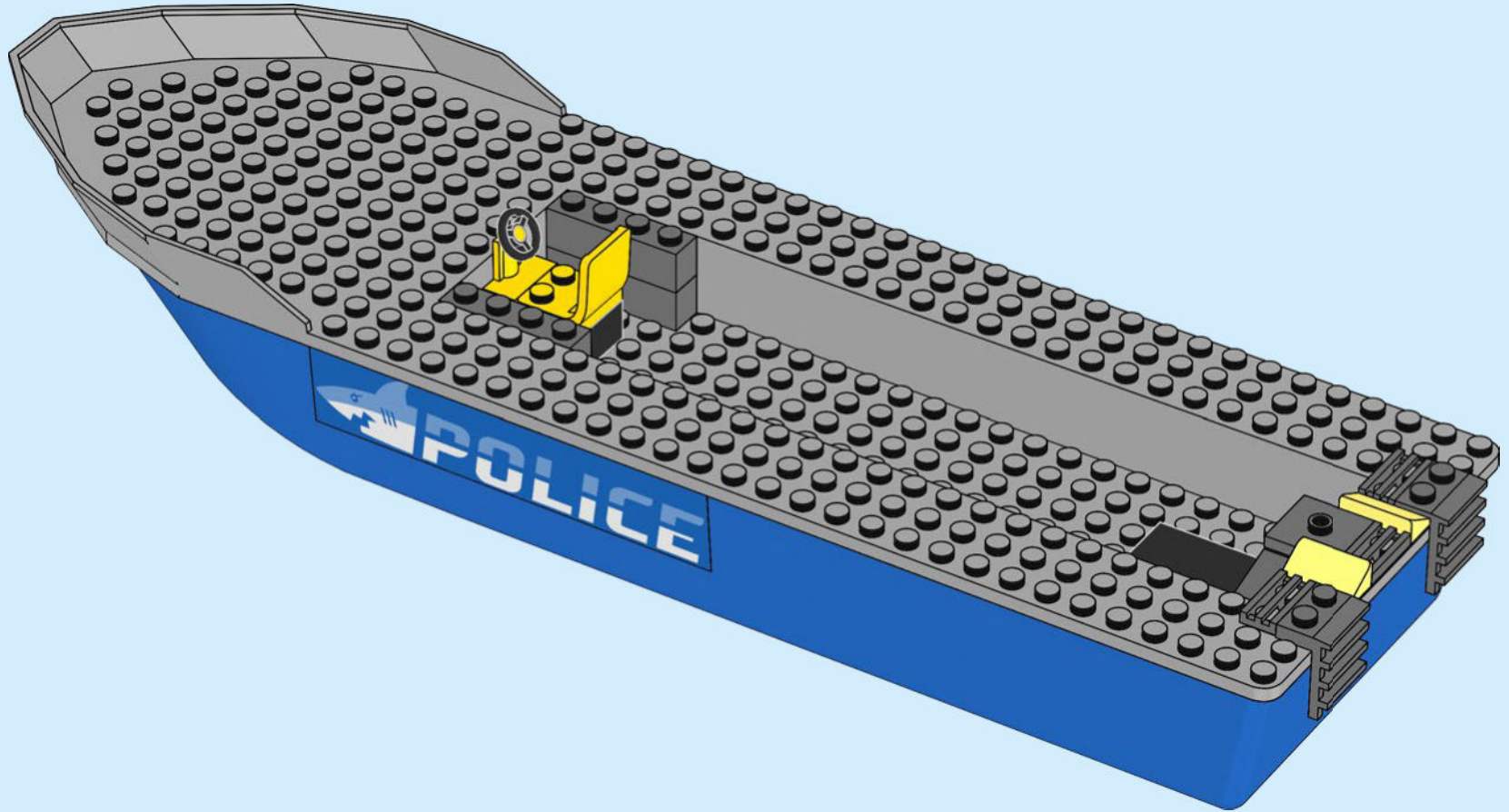



2x

9

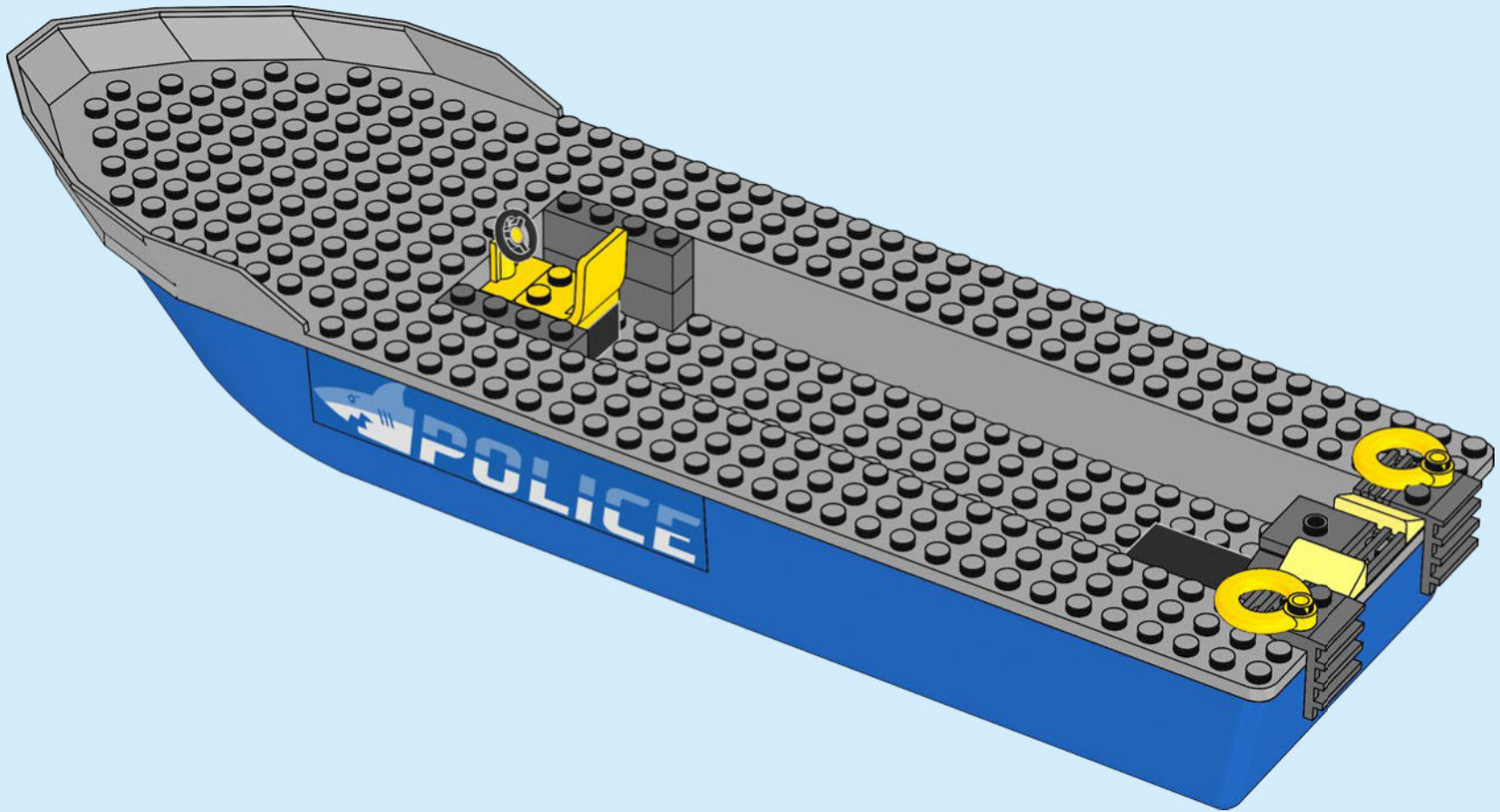



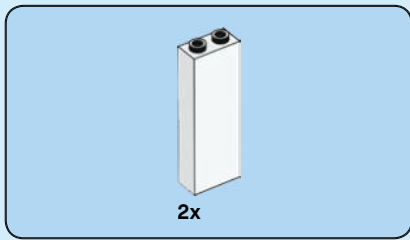

10

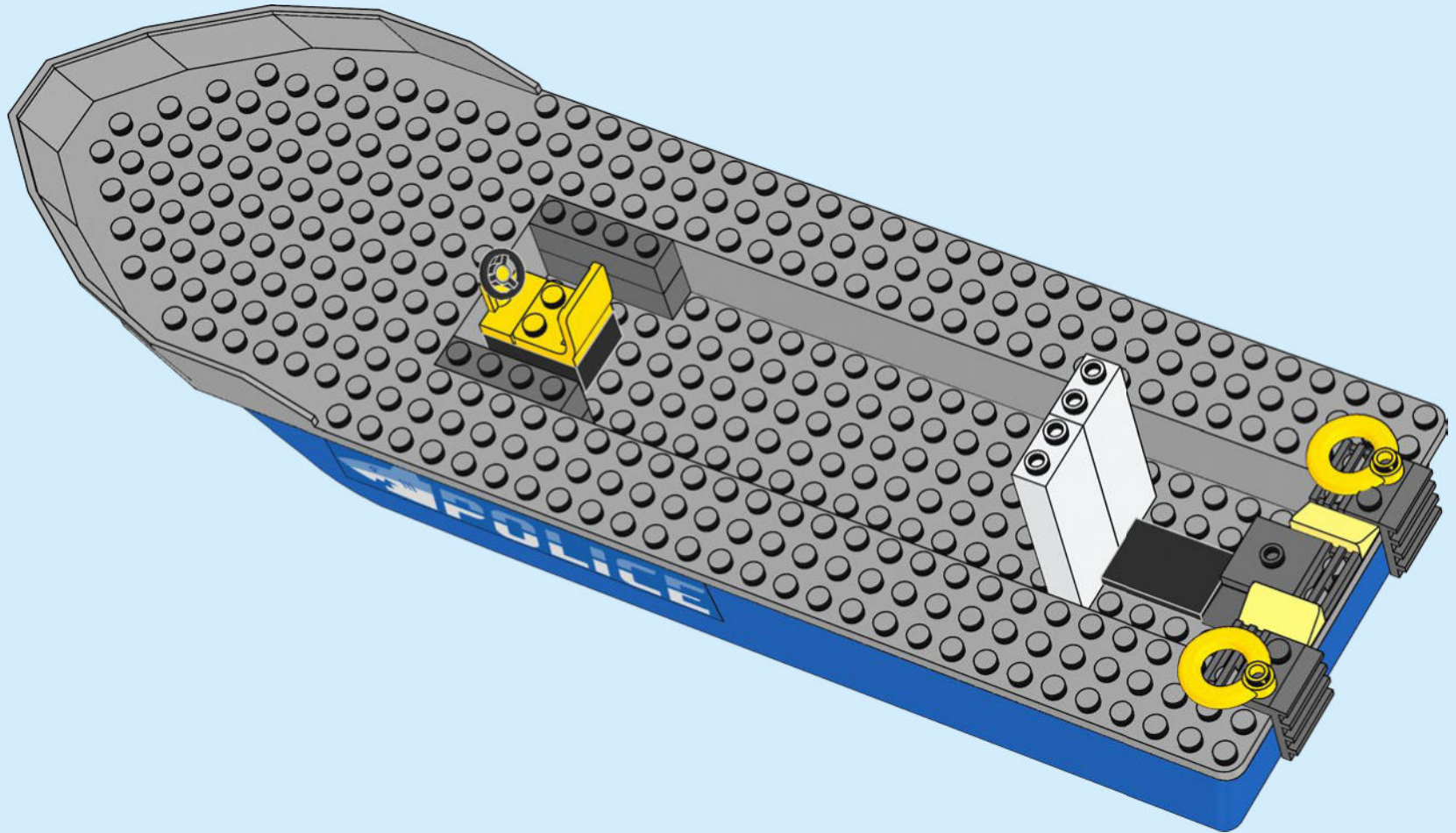

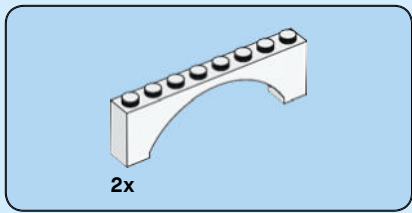

11

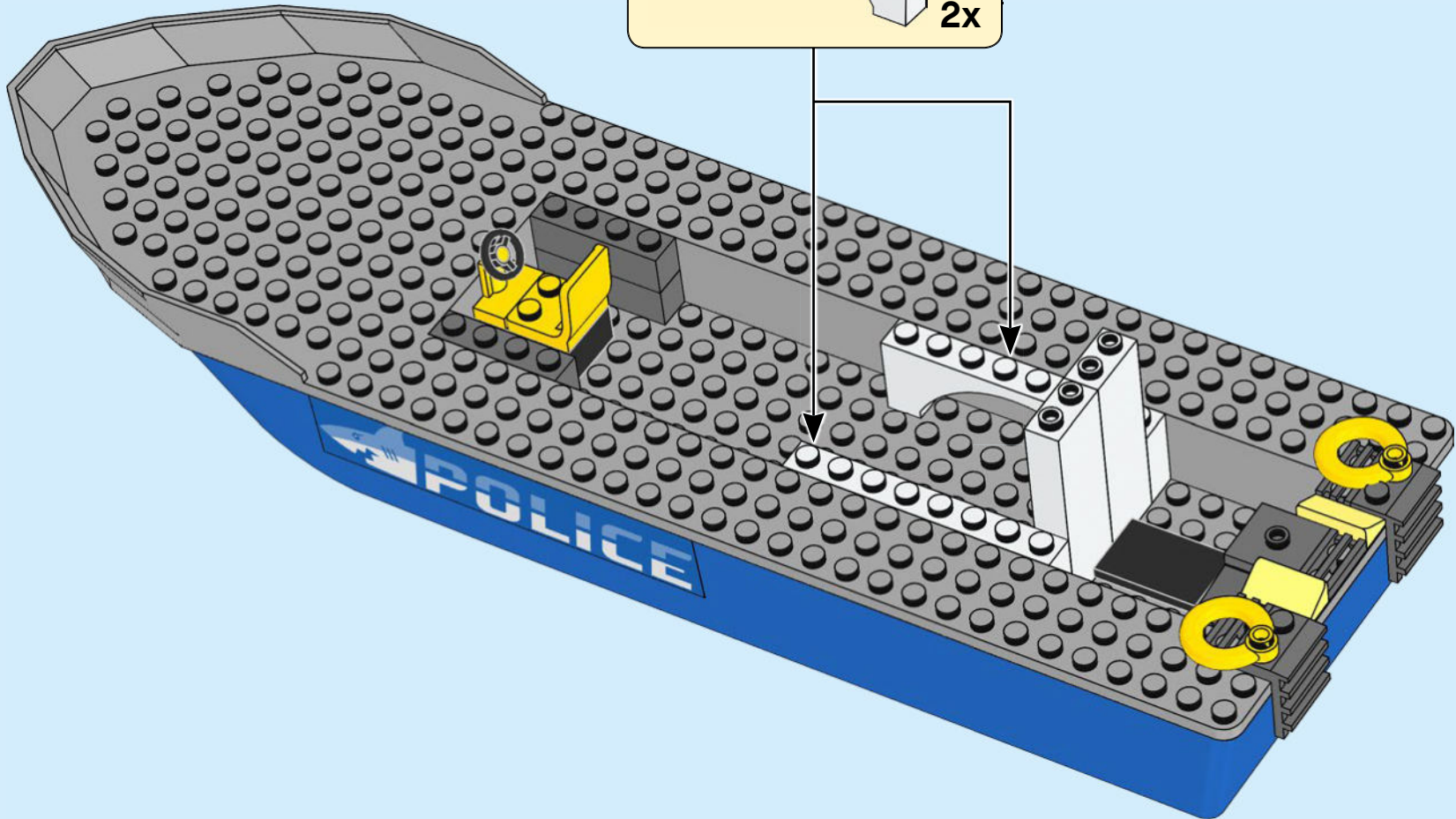
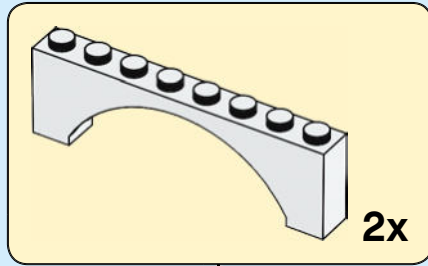

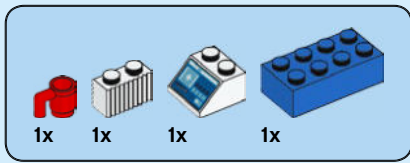

12

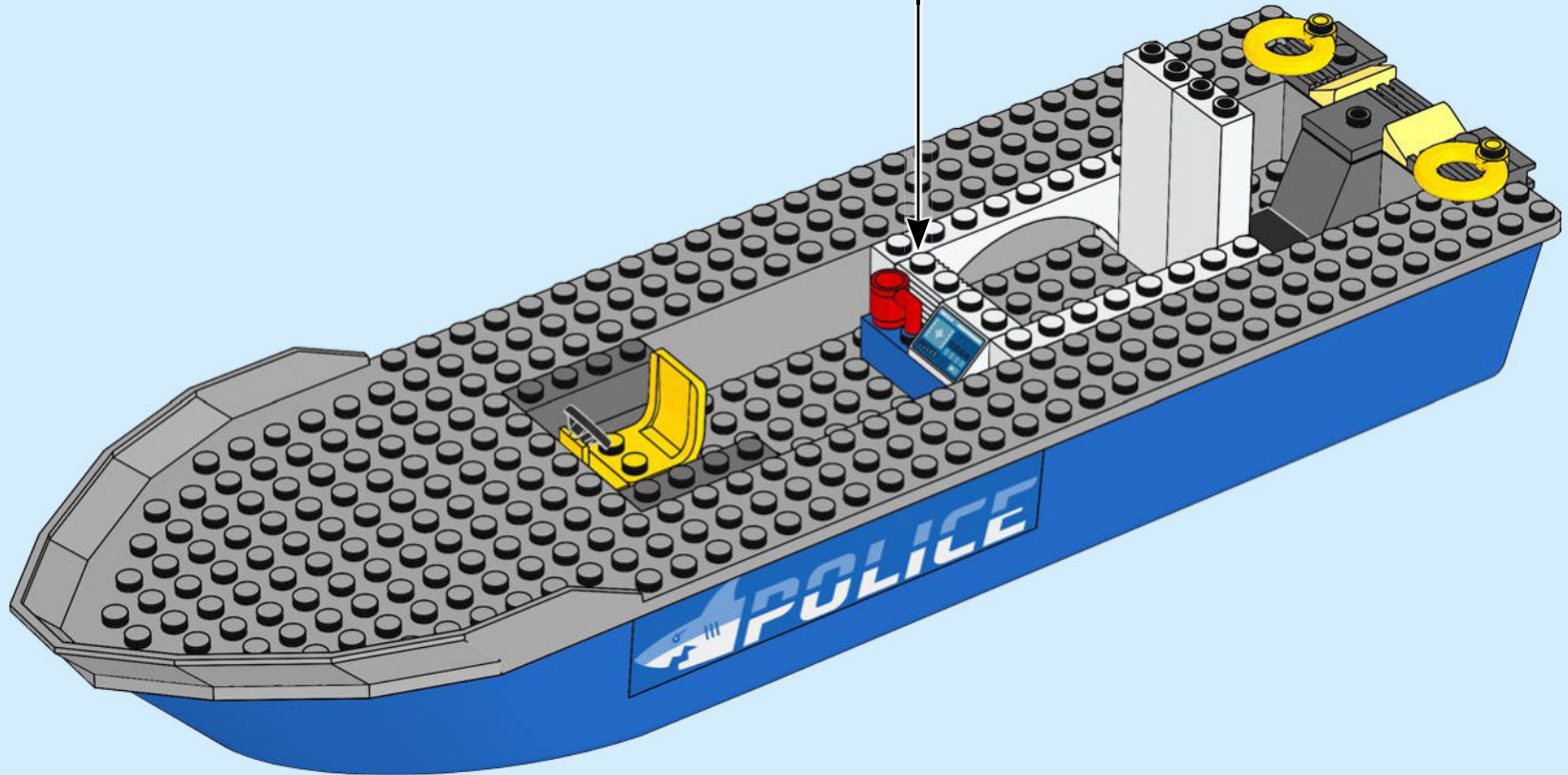
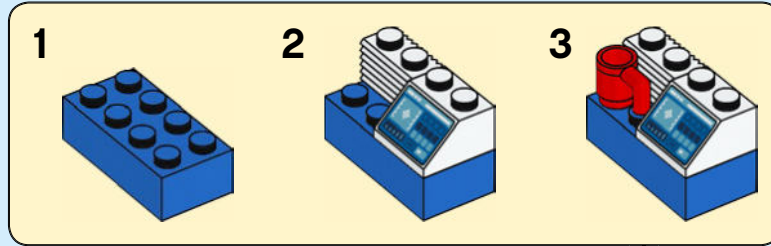



13

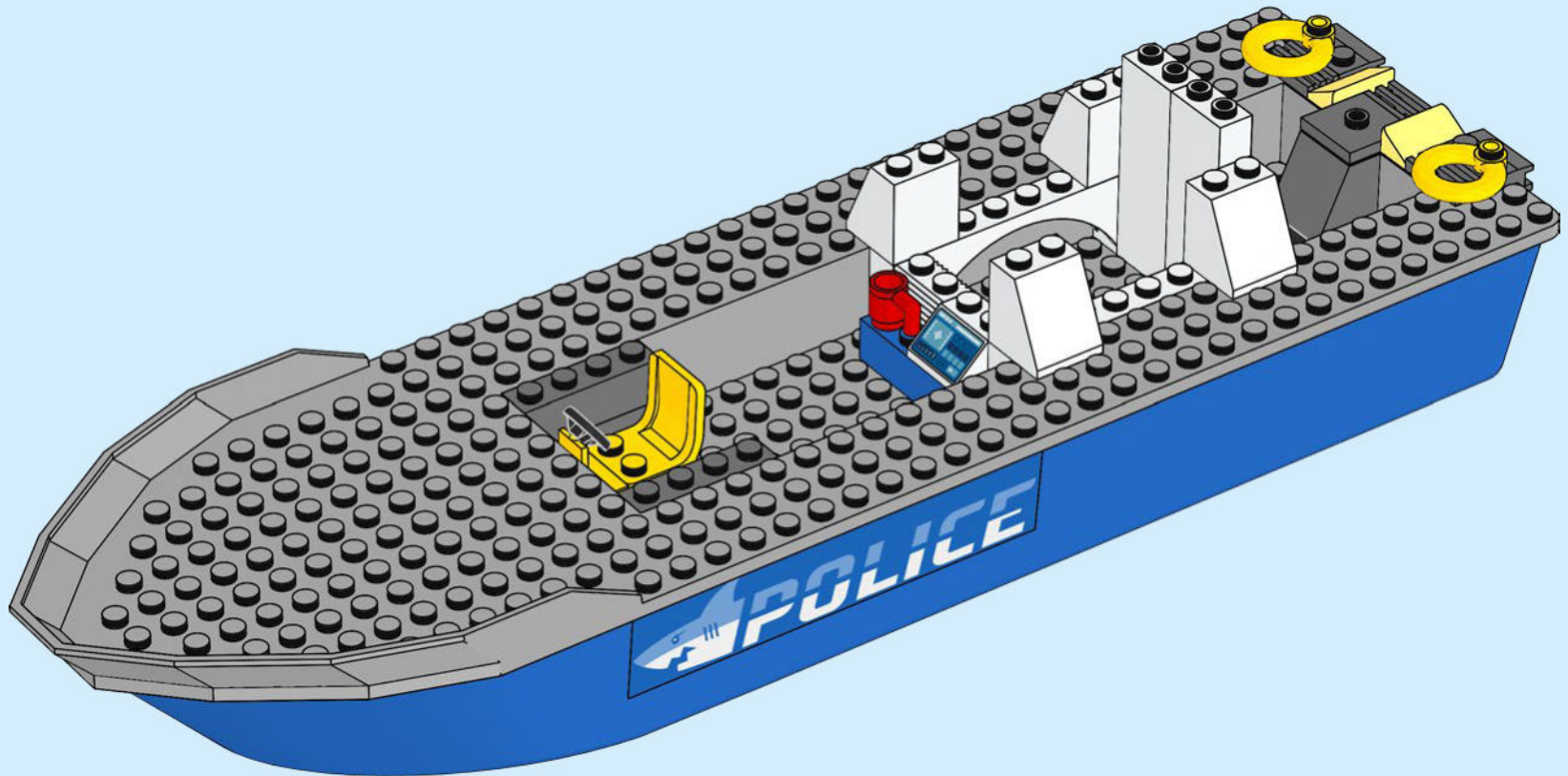

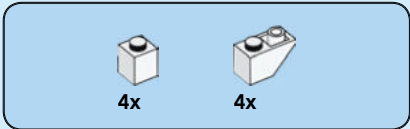

14

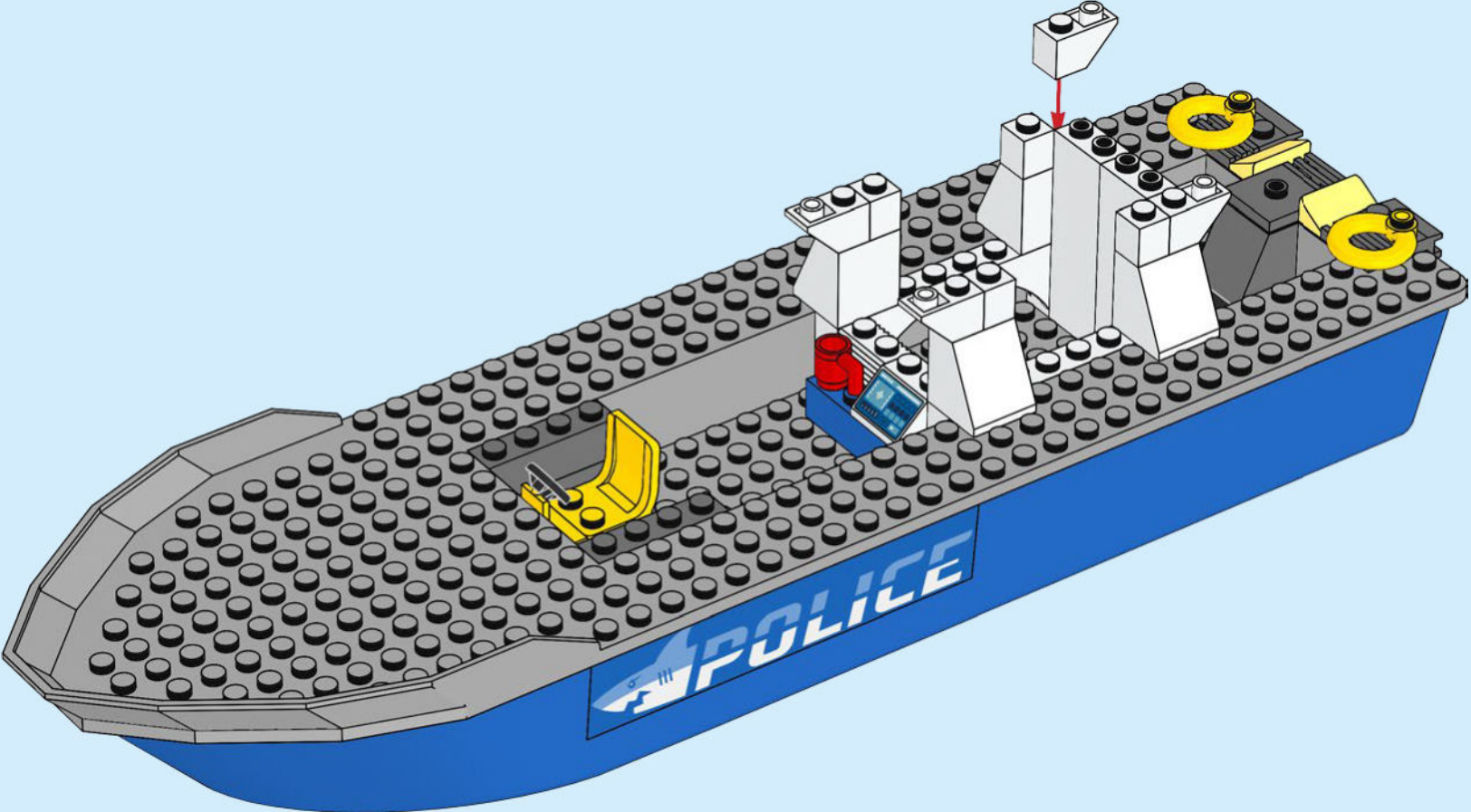

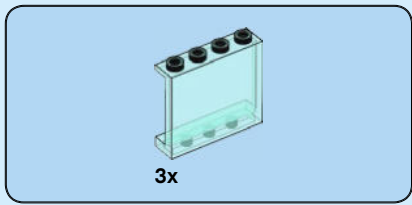

15

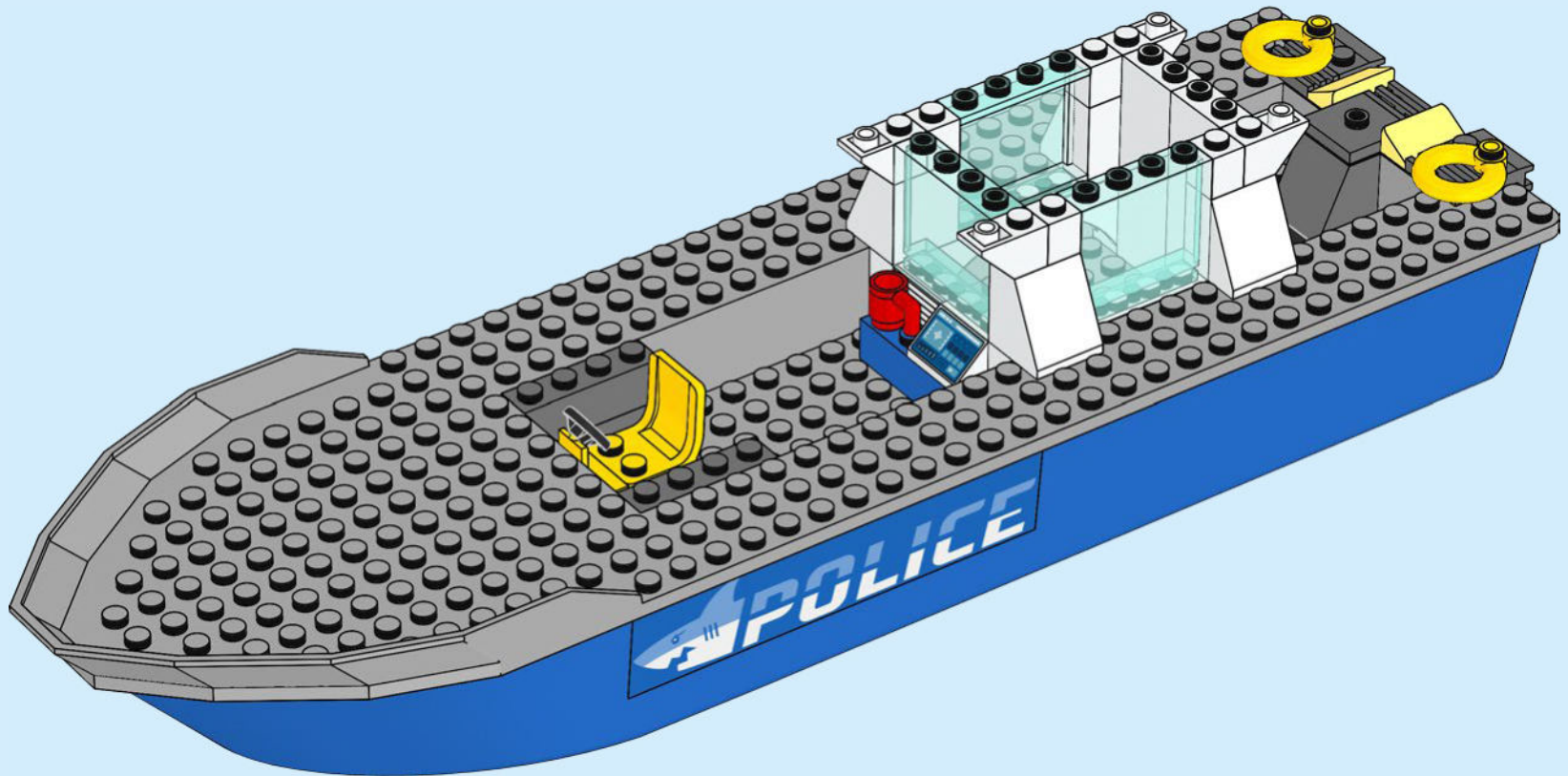

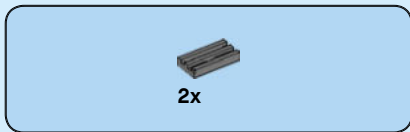

16

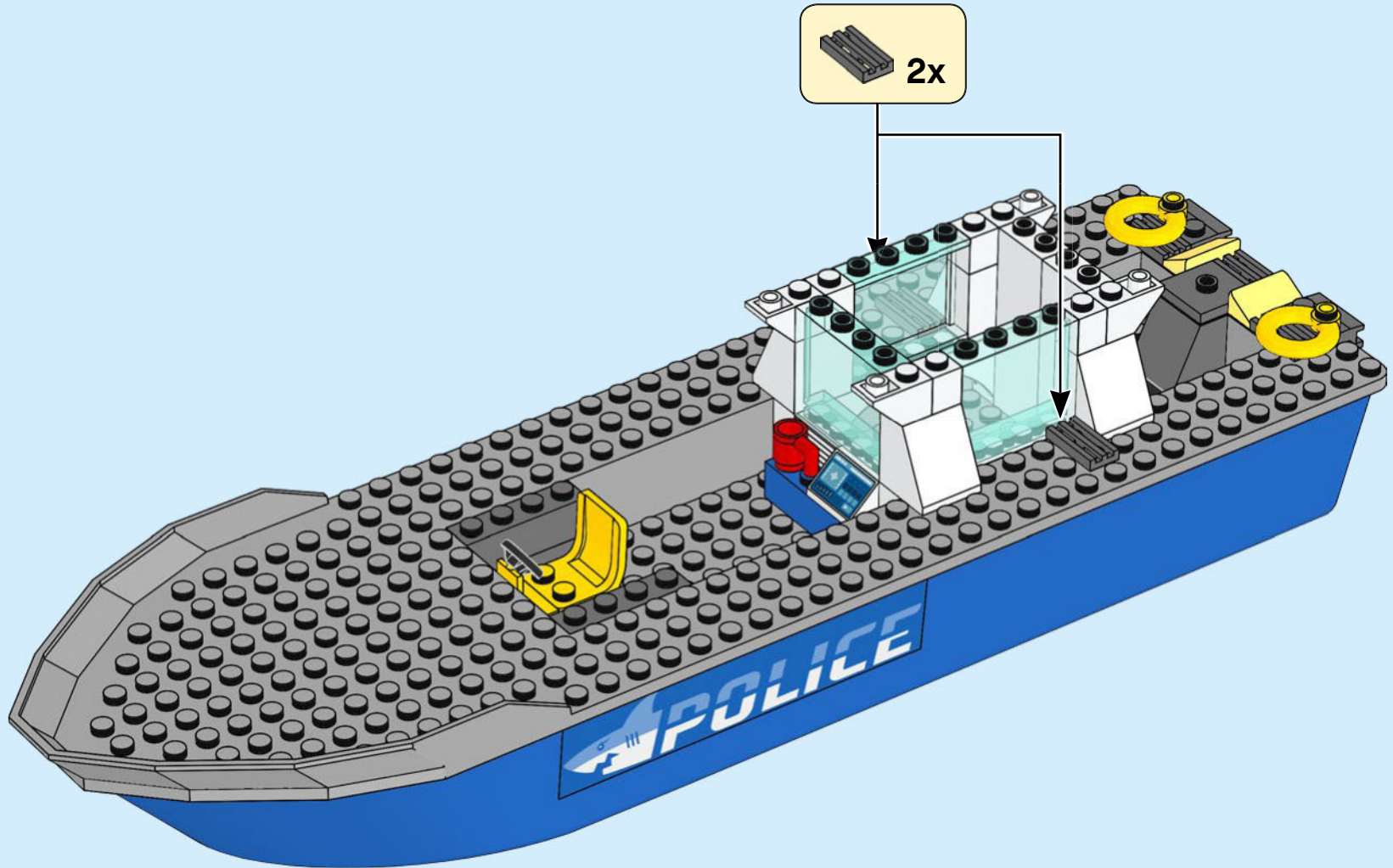

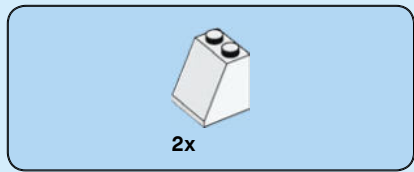

17

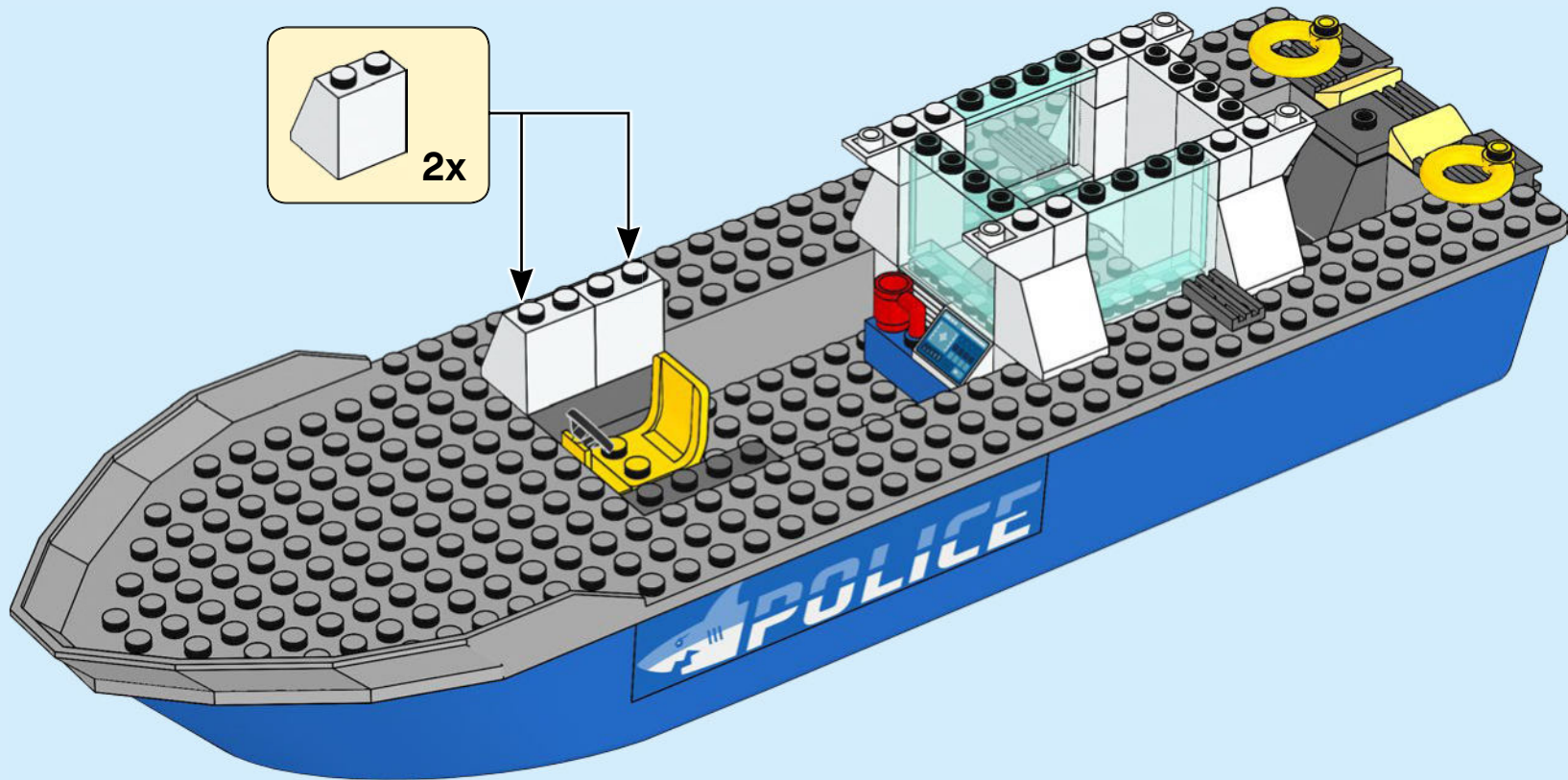



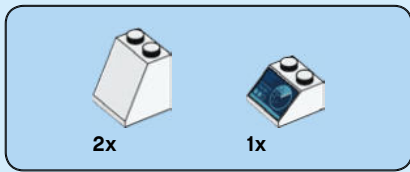

18

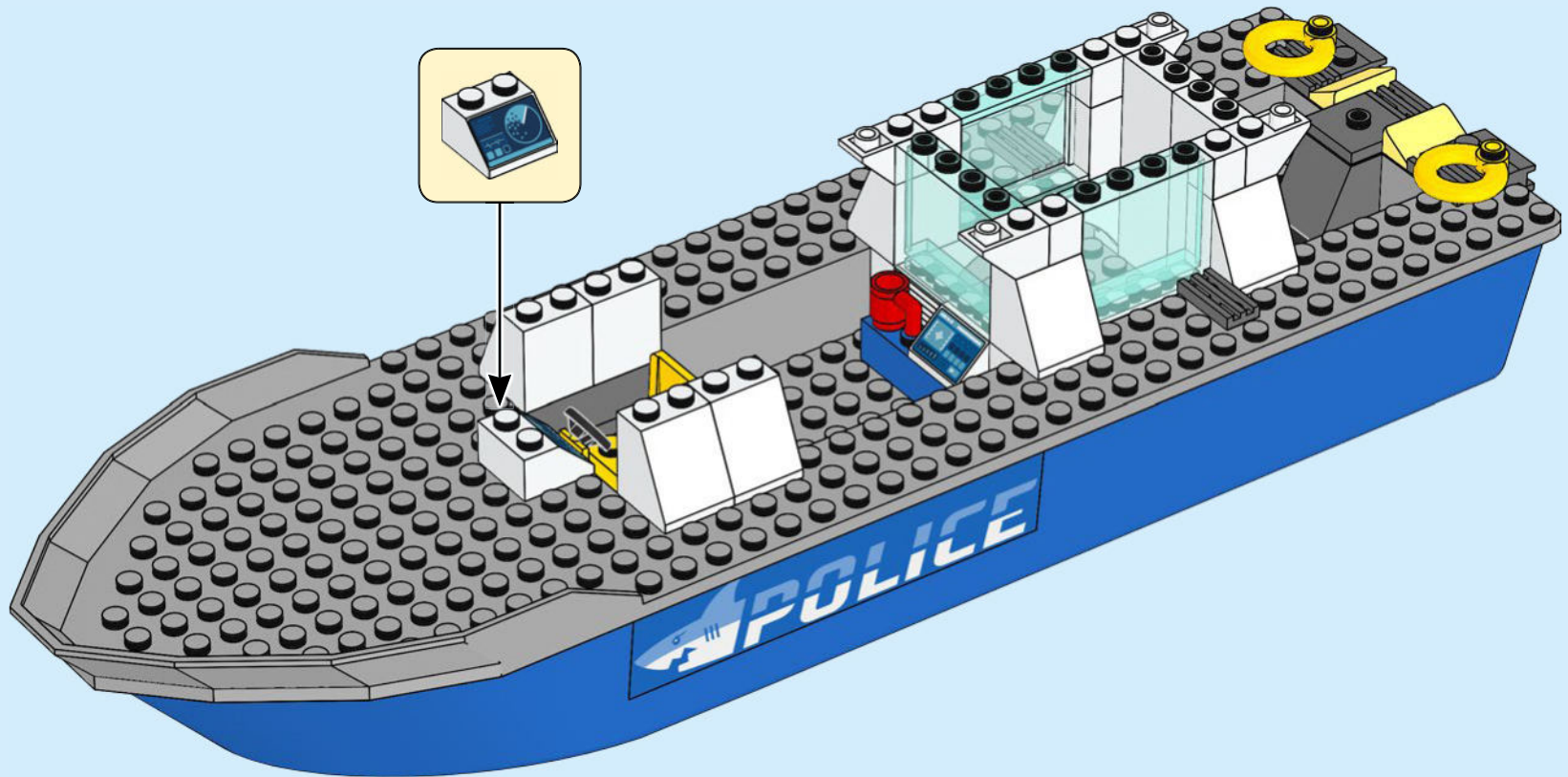



2x

19

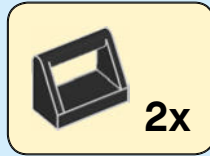

2x

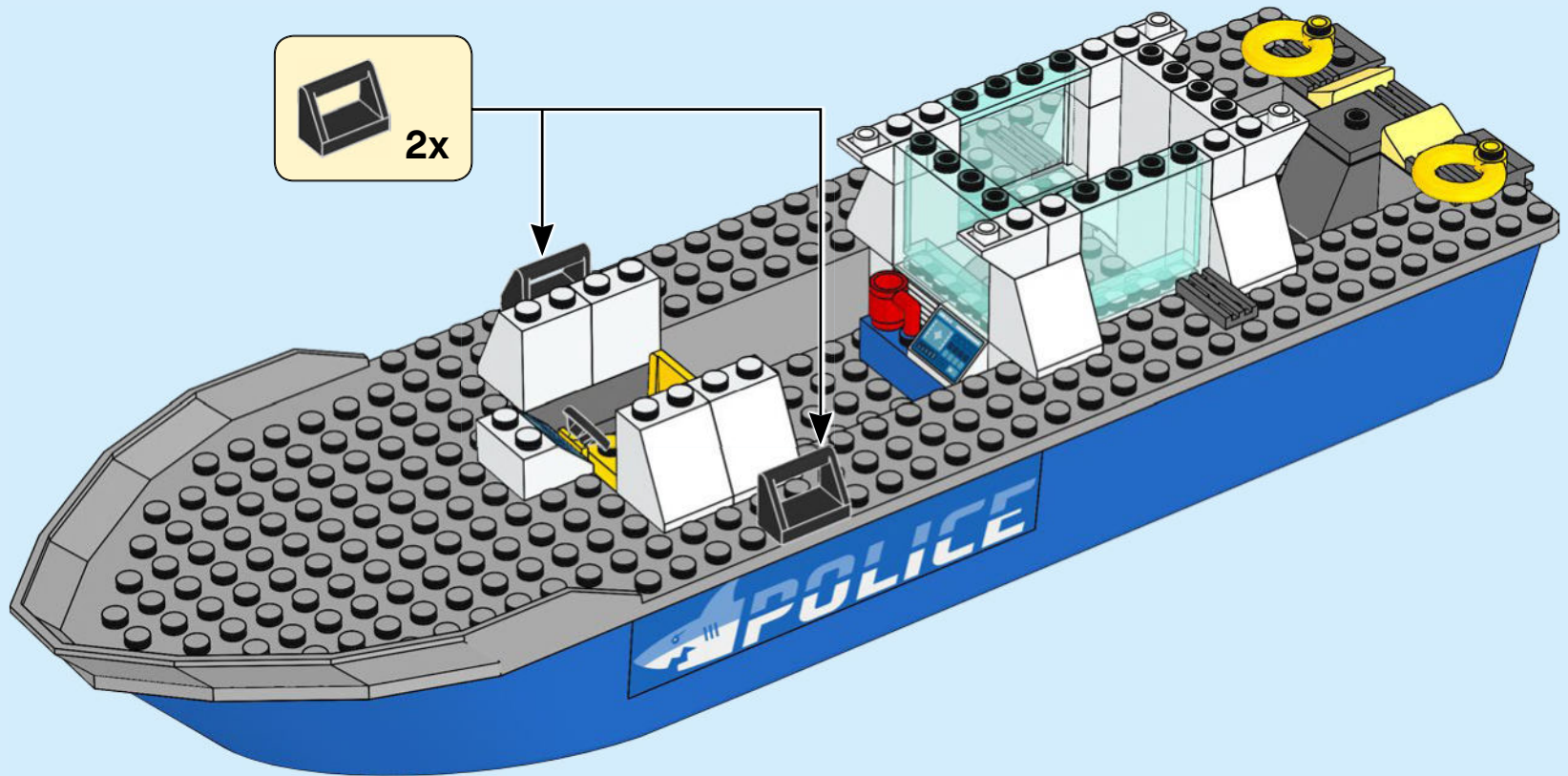



20

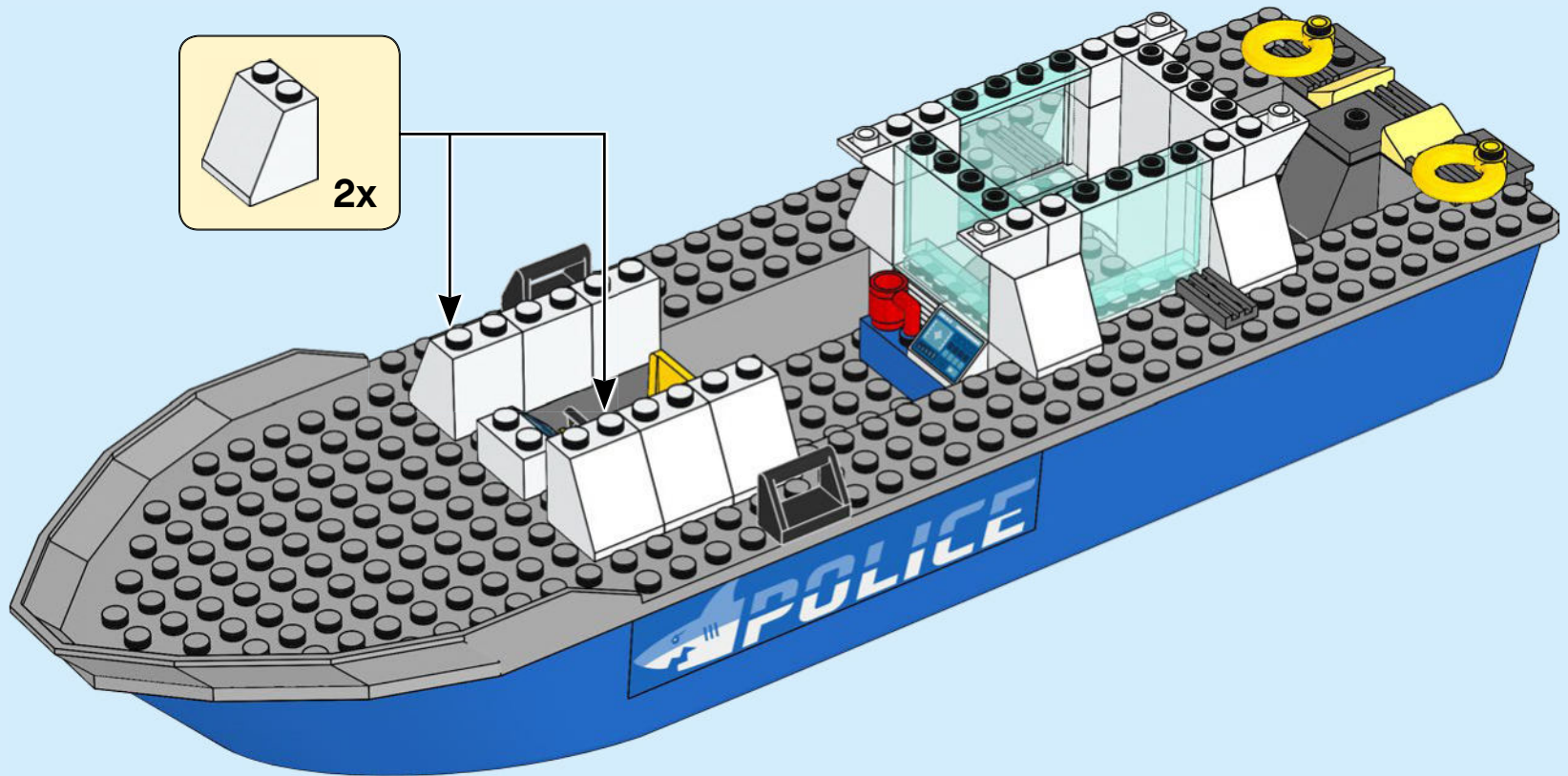

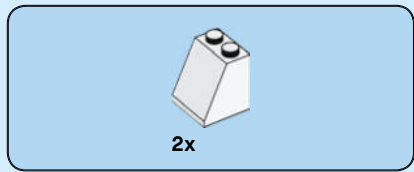

21

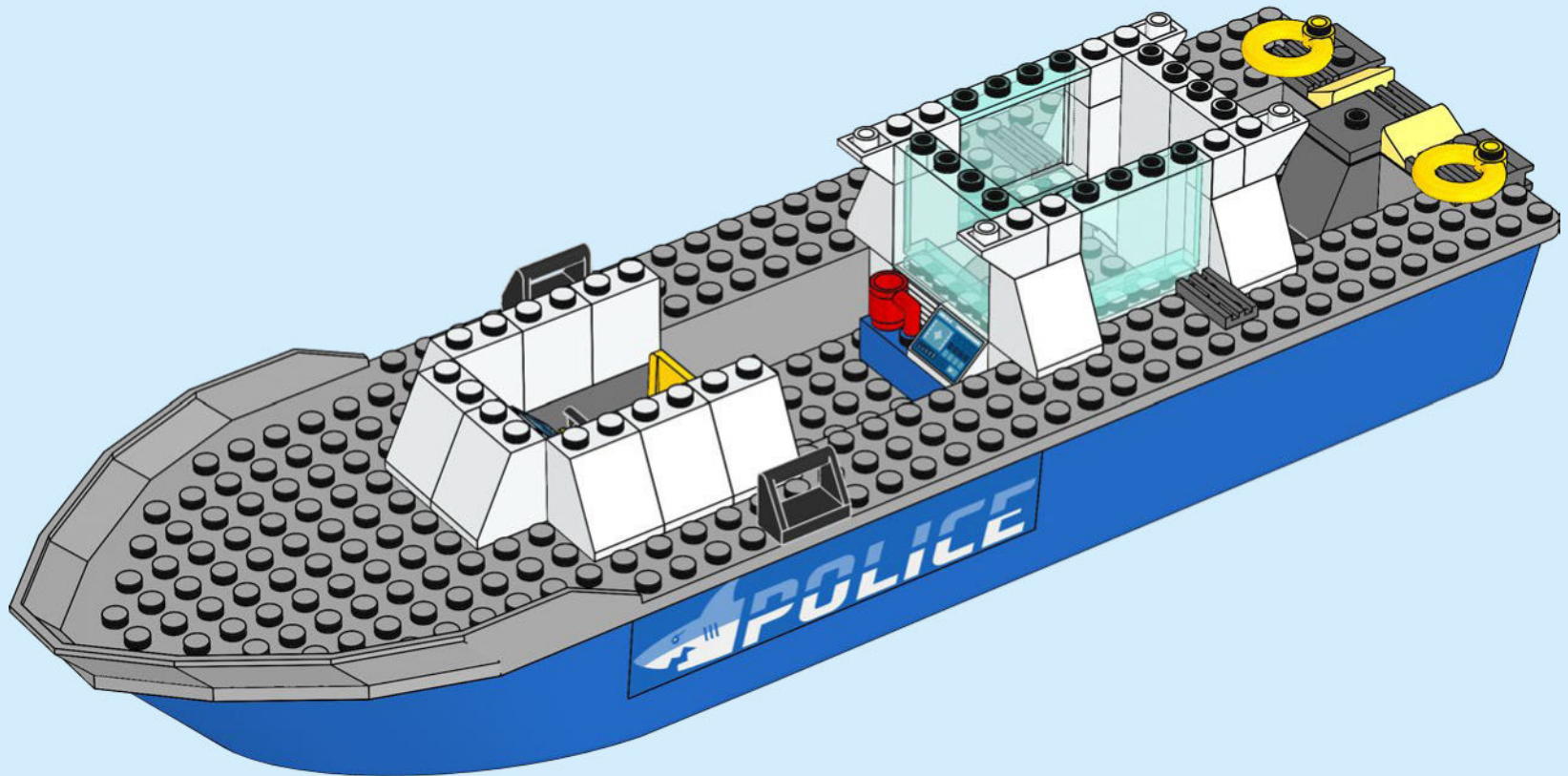



2x

22

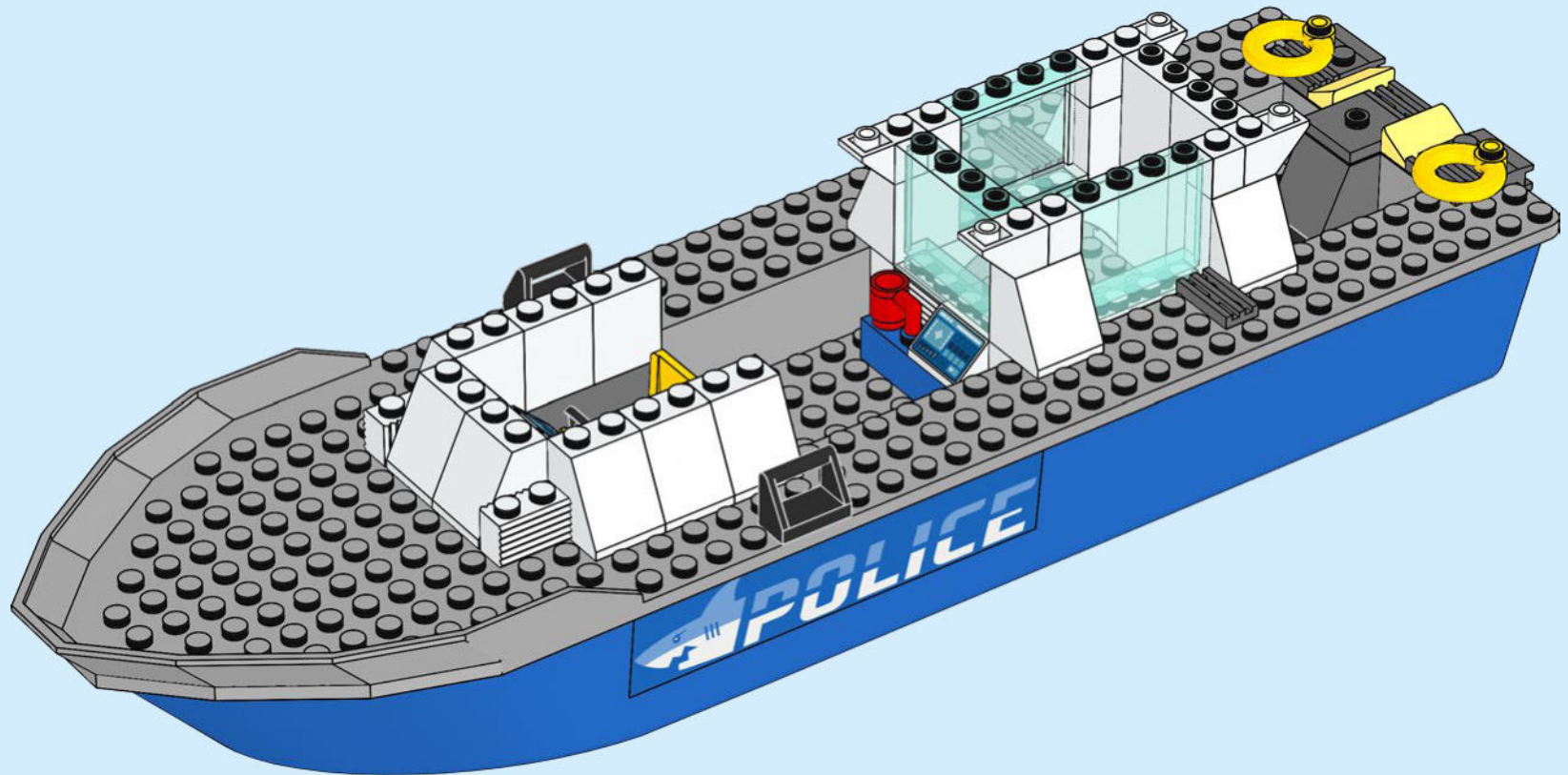

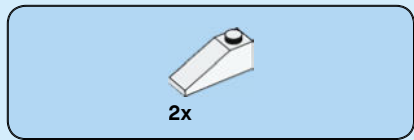

23

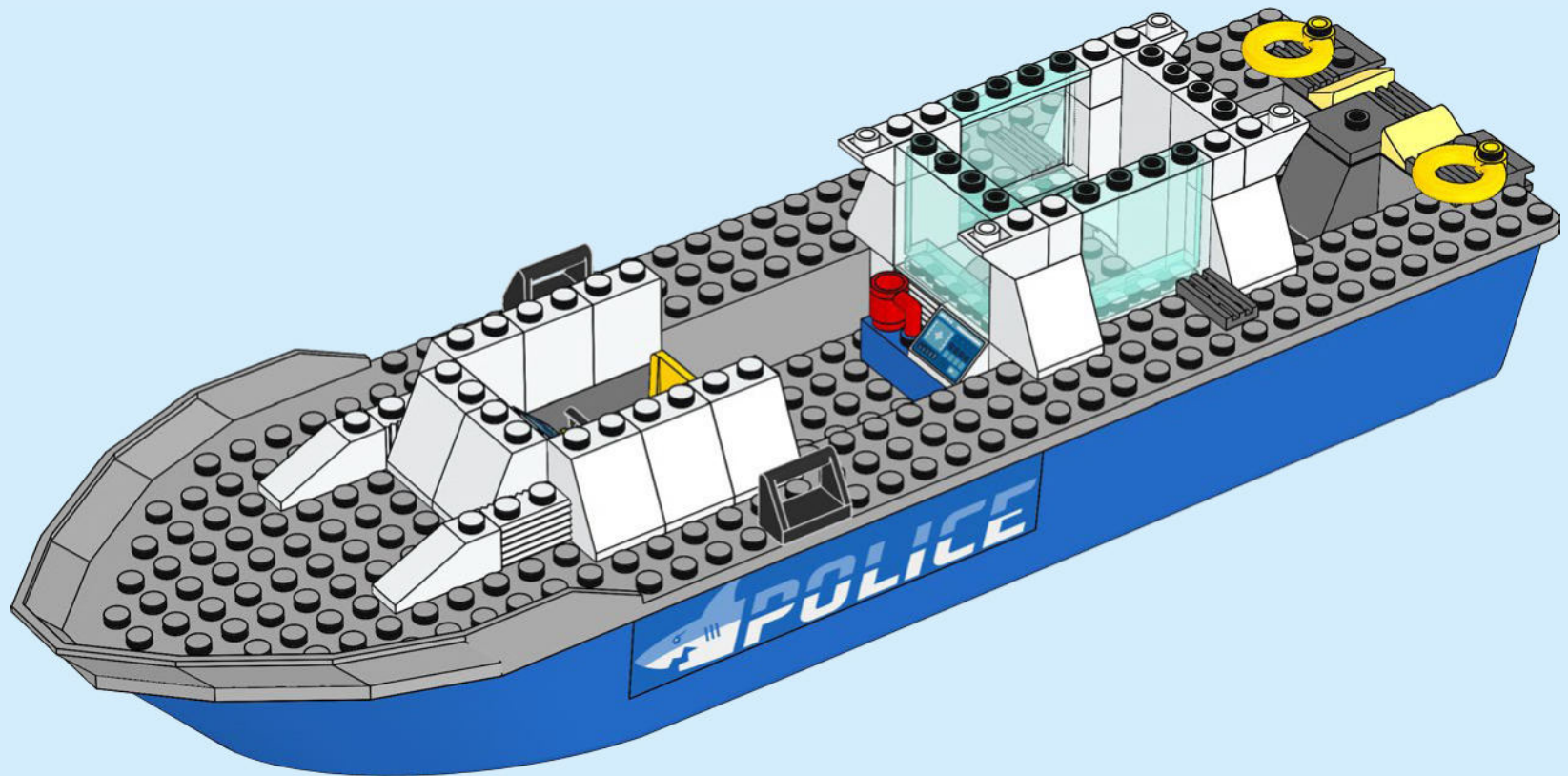

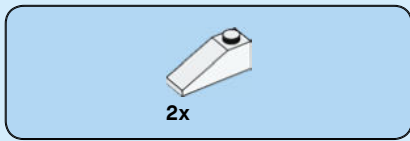

24

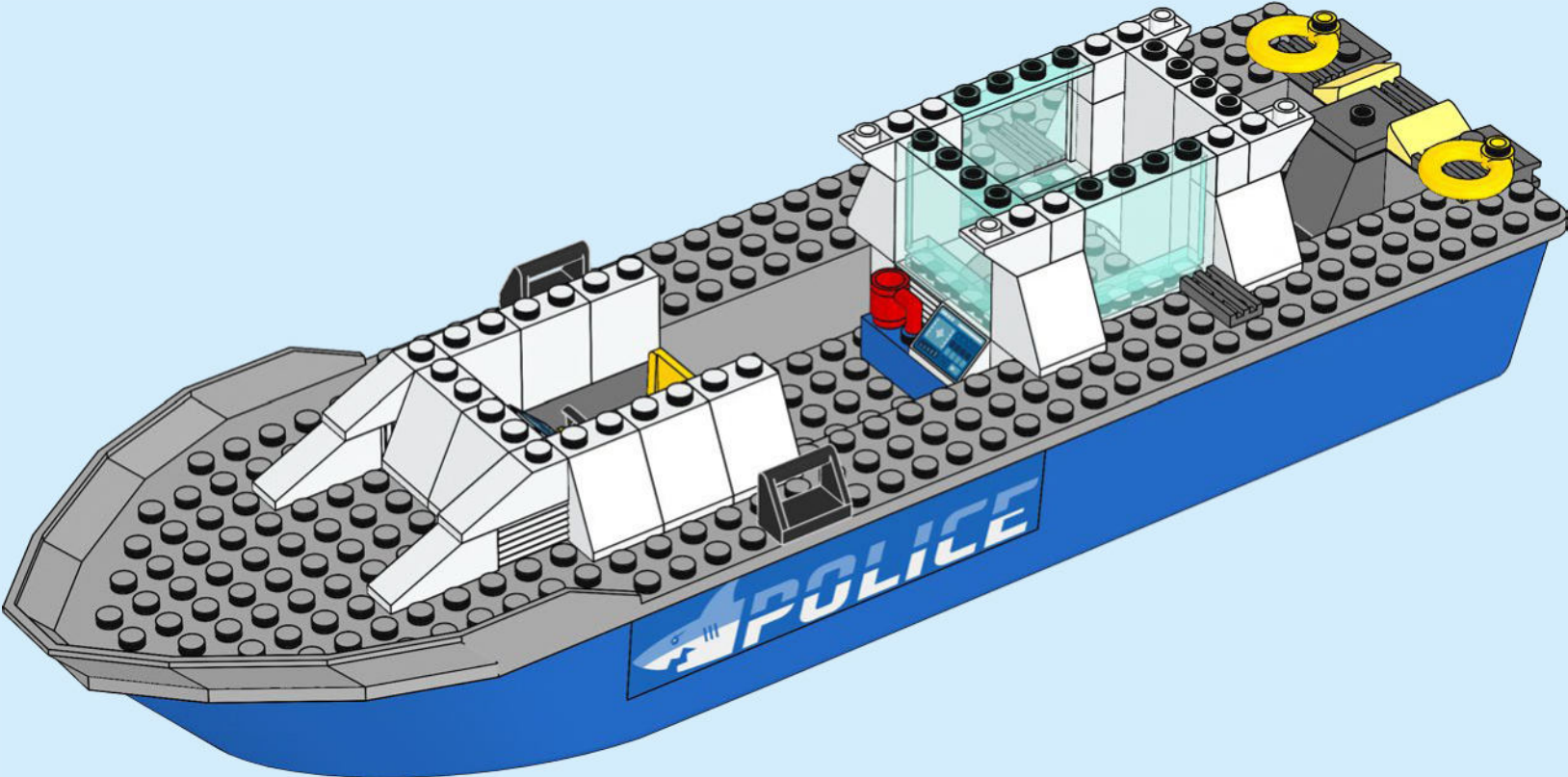



2x

25

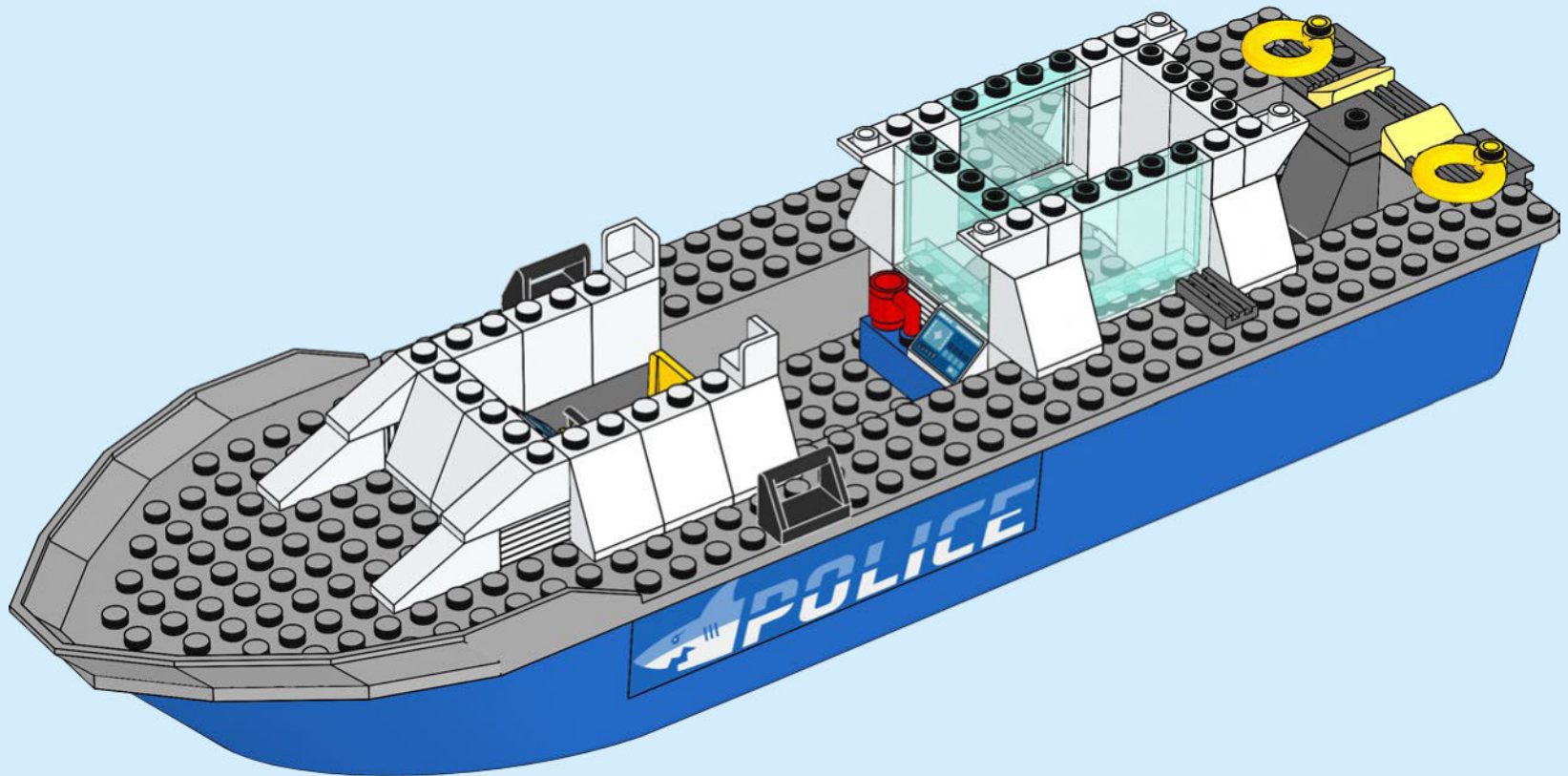



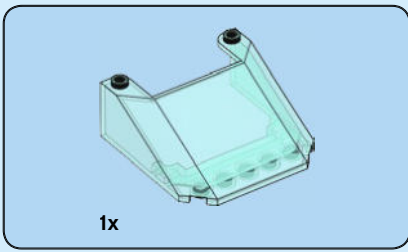

26

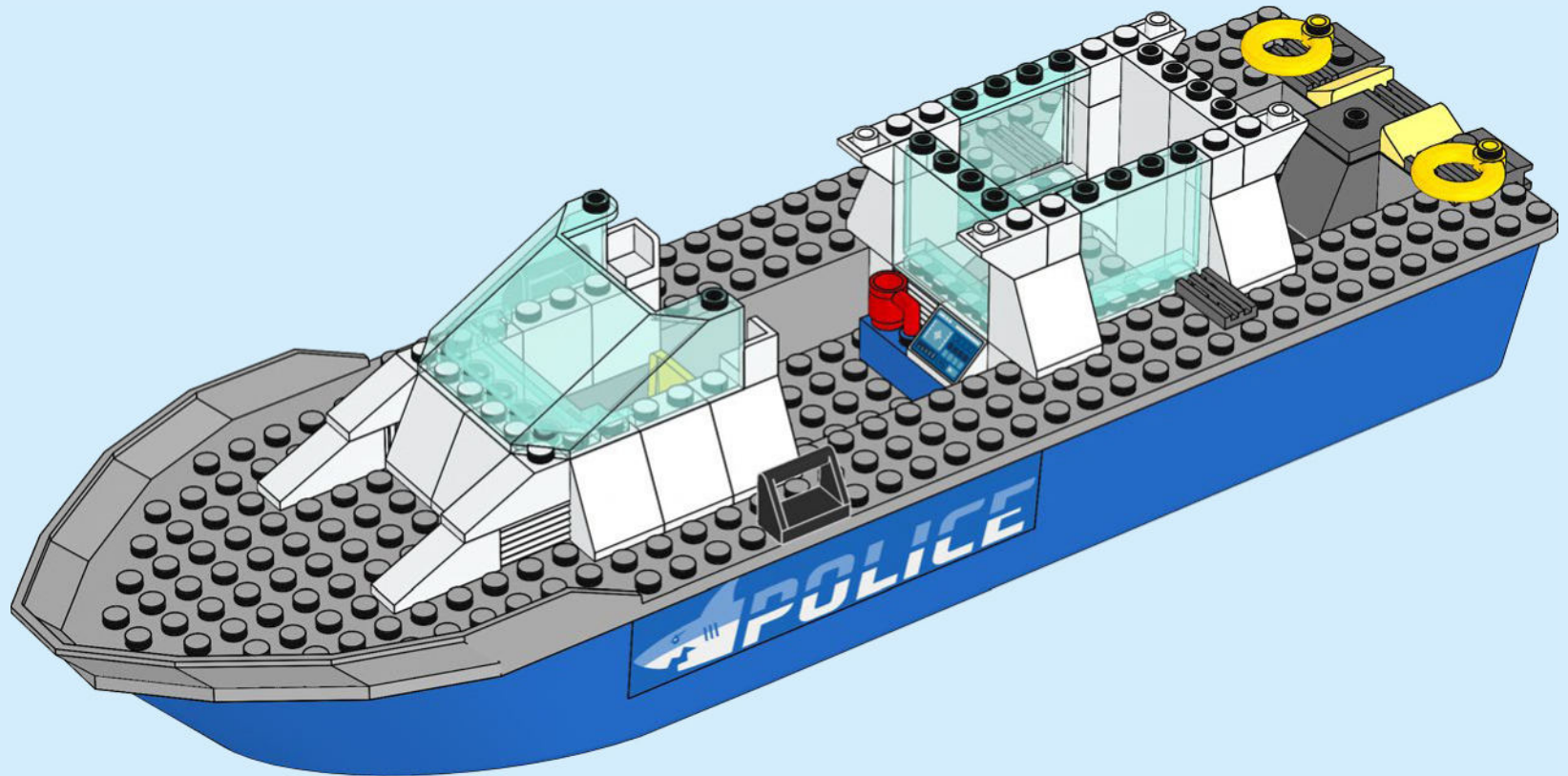



3x

27

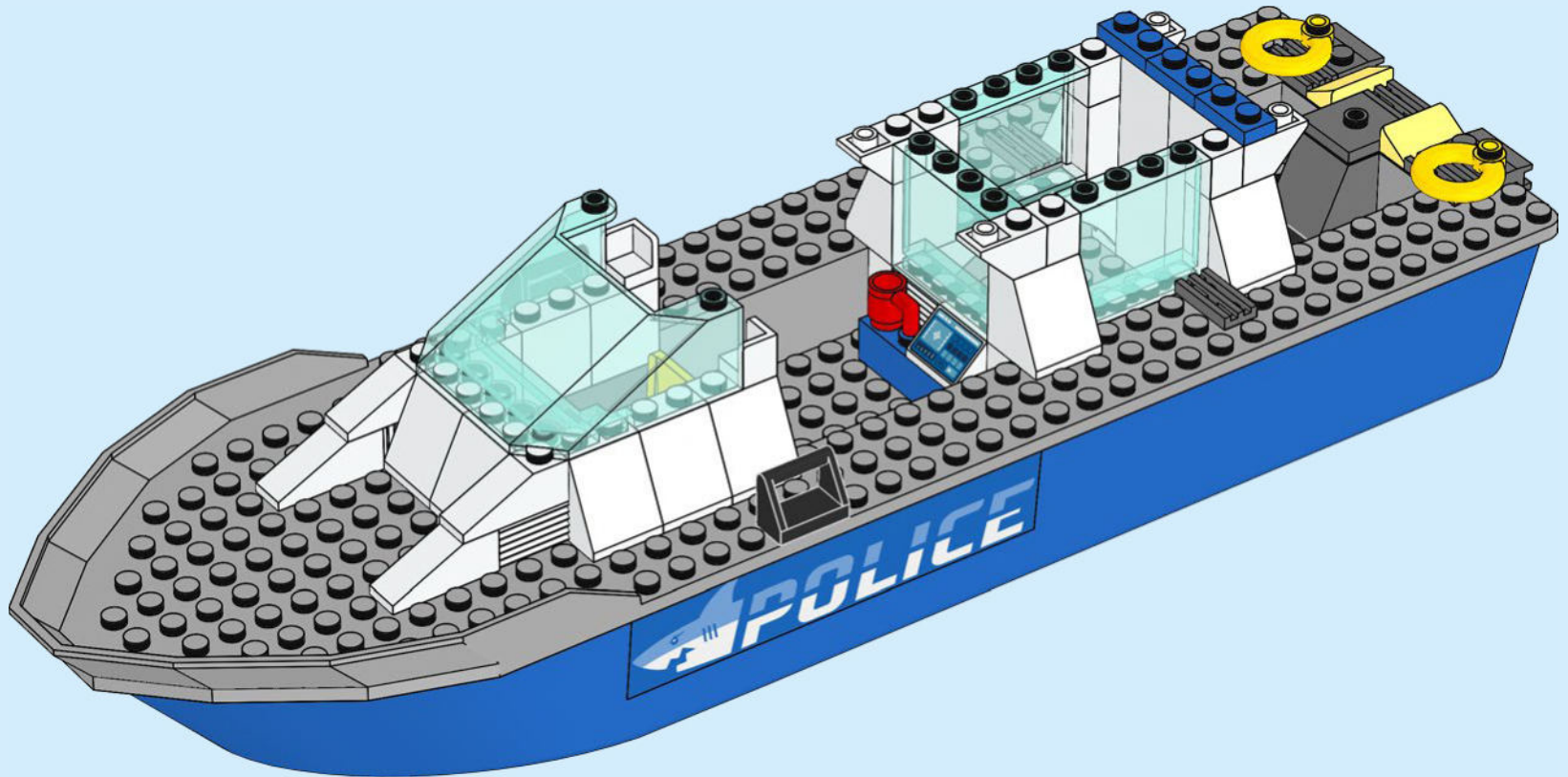

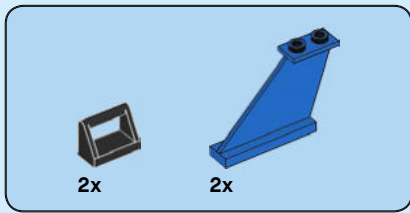

28

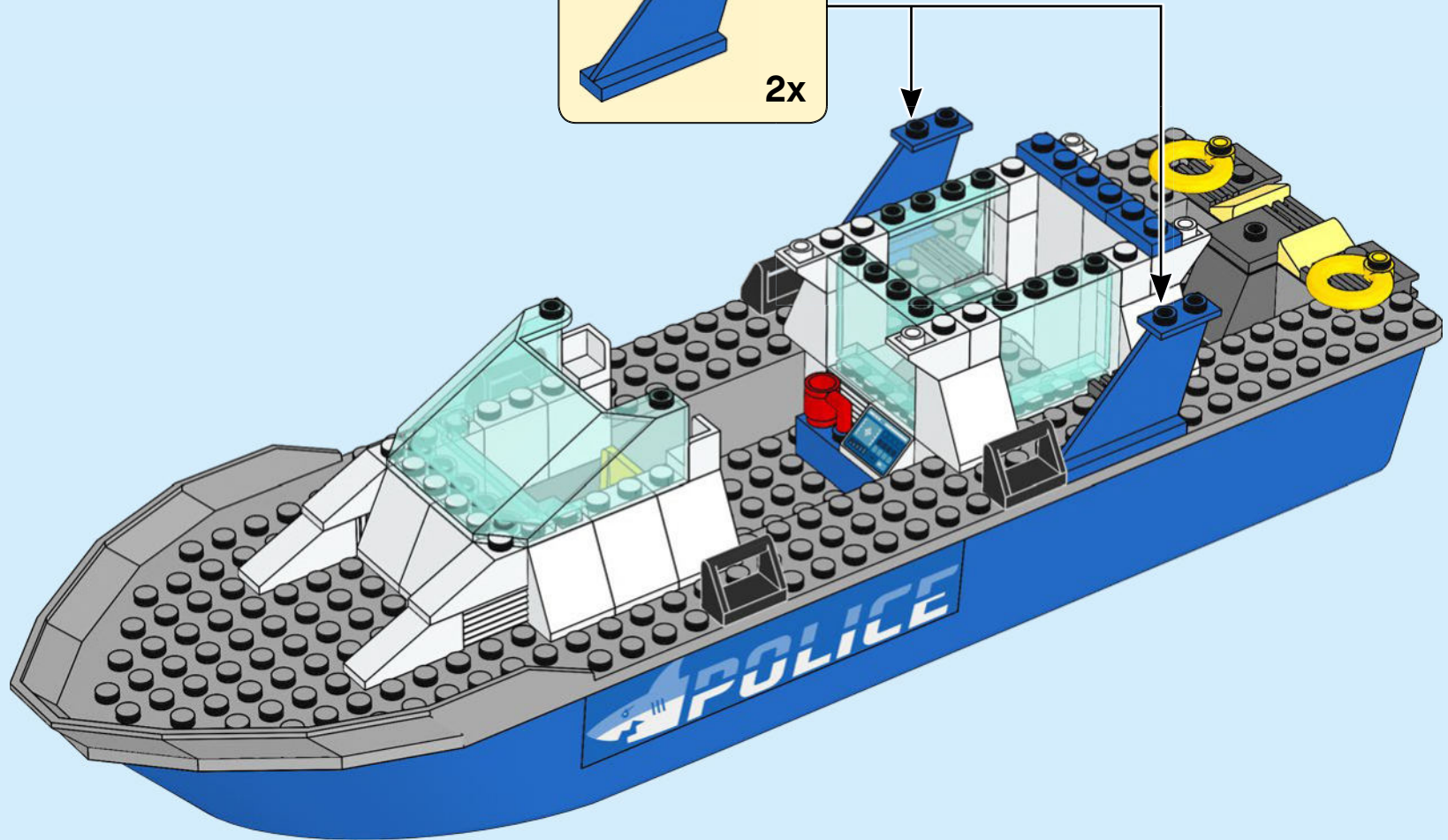
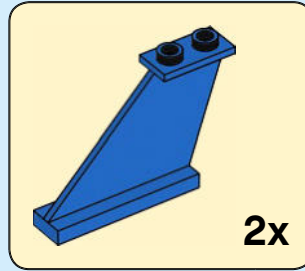

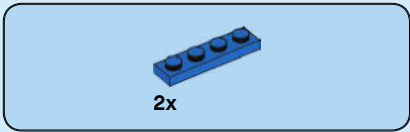

29

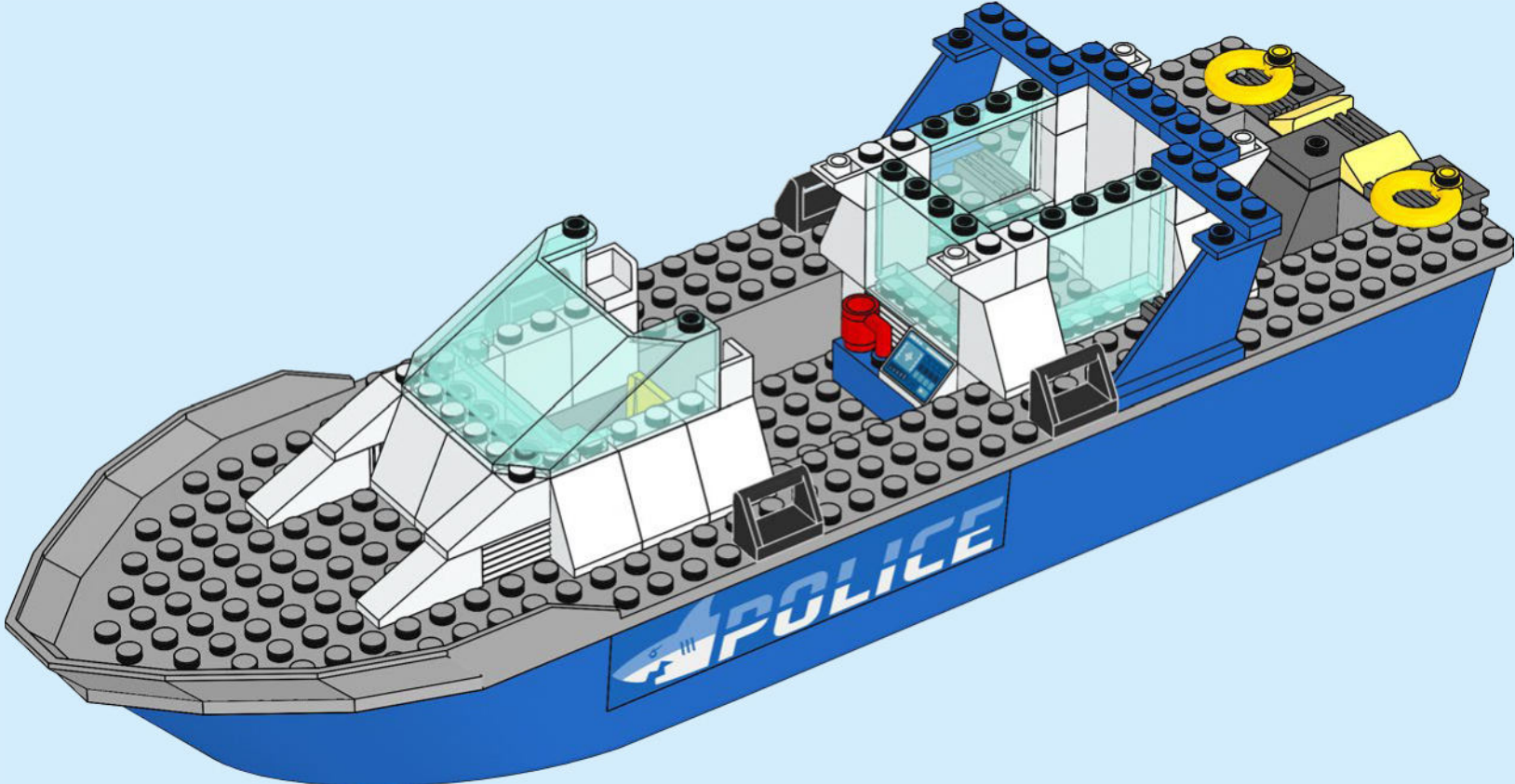

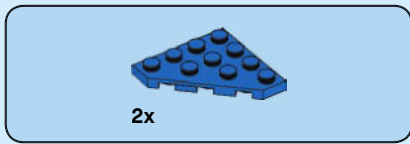

30

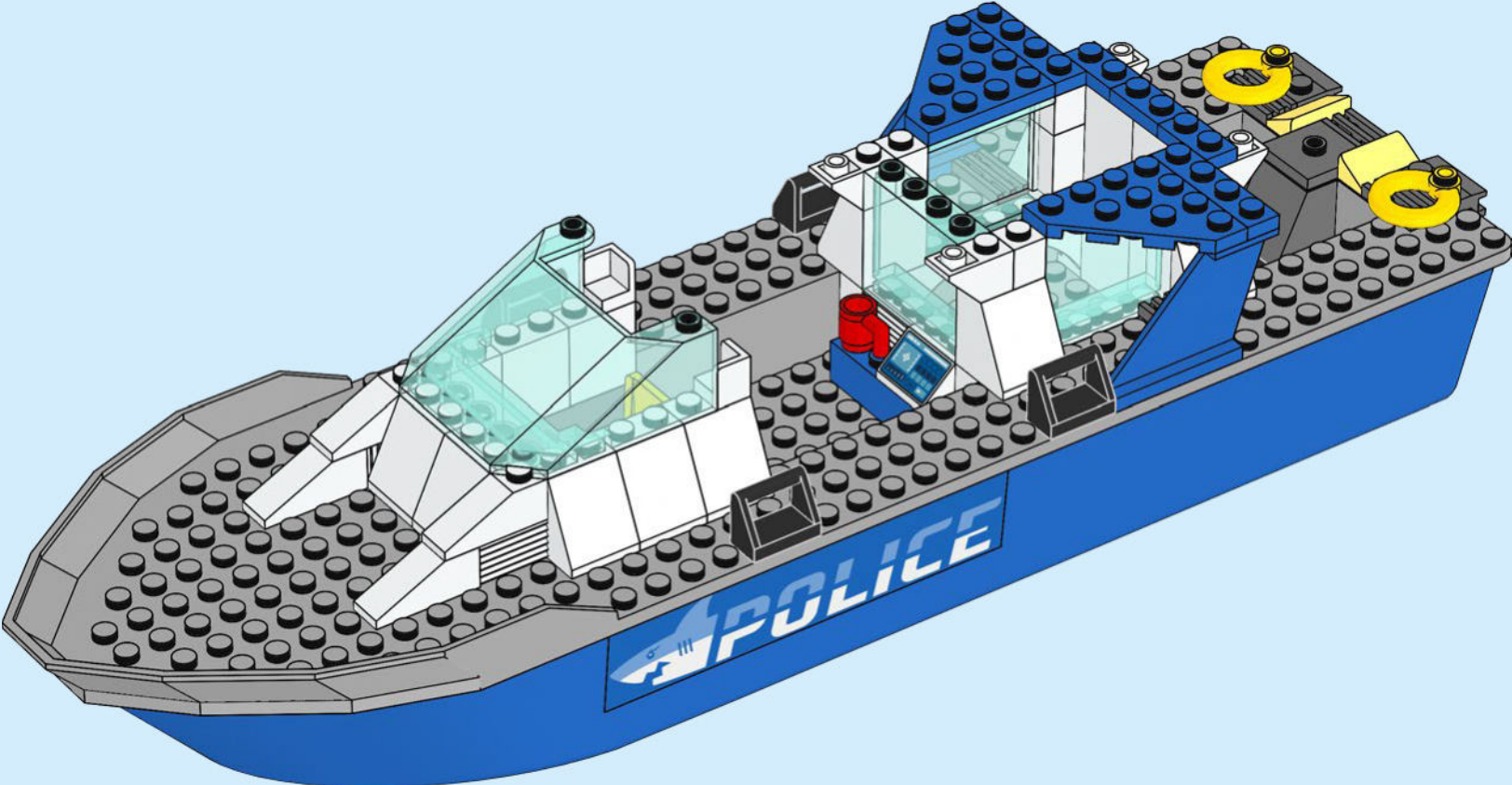

2x  2x 

31

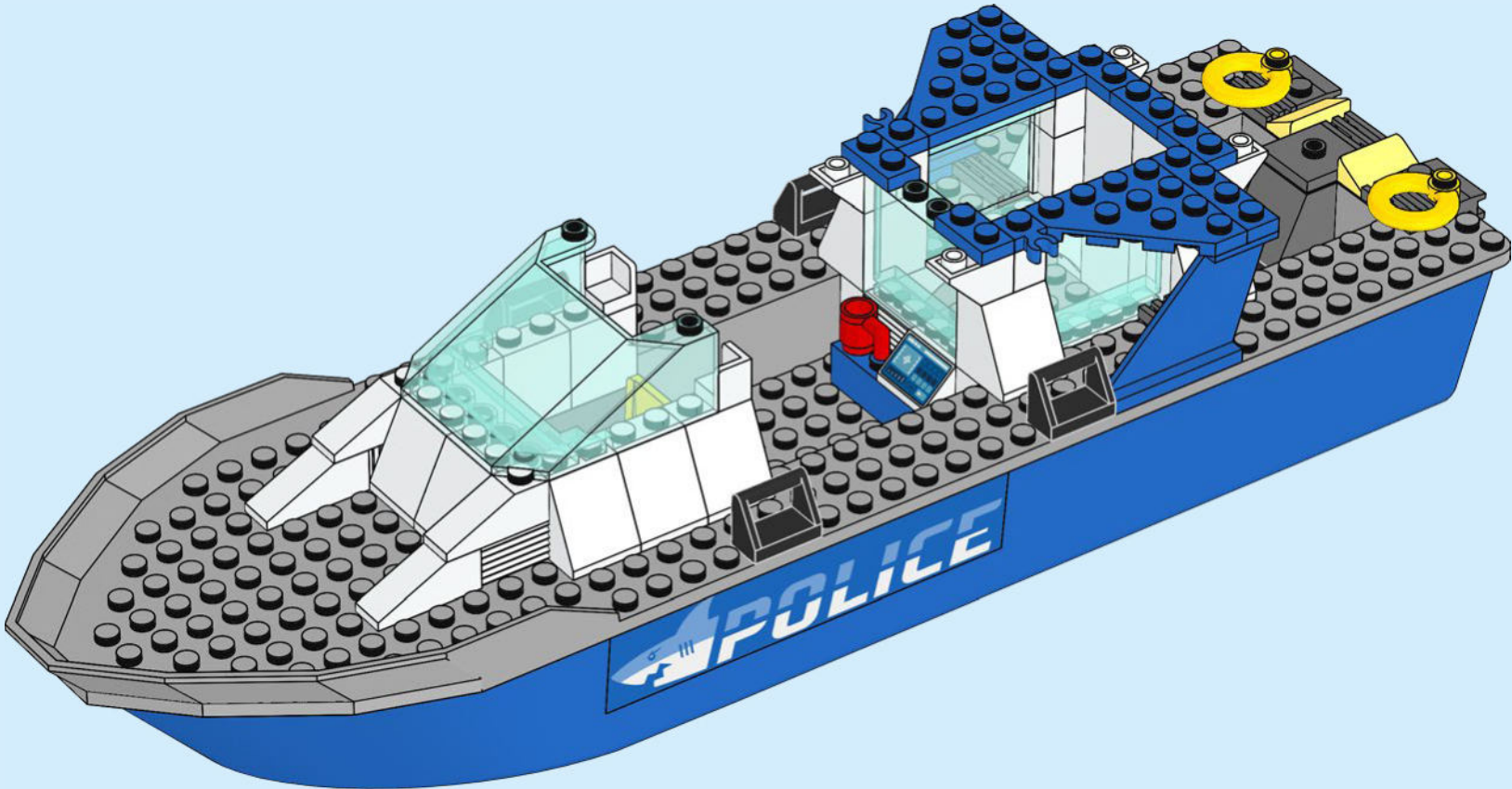

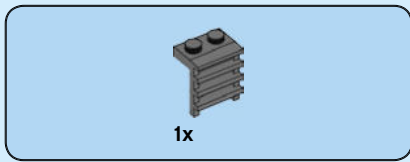

32

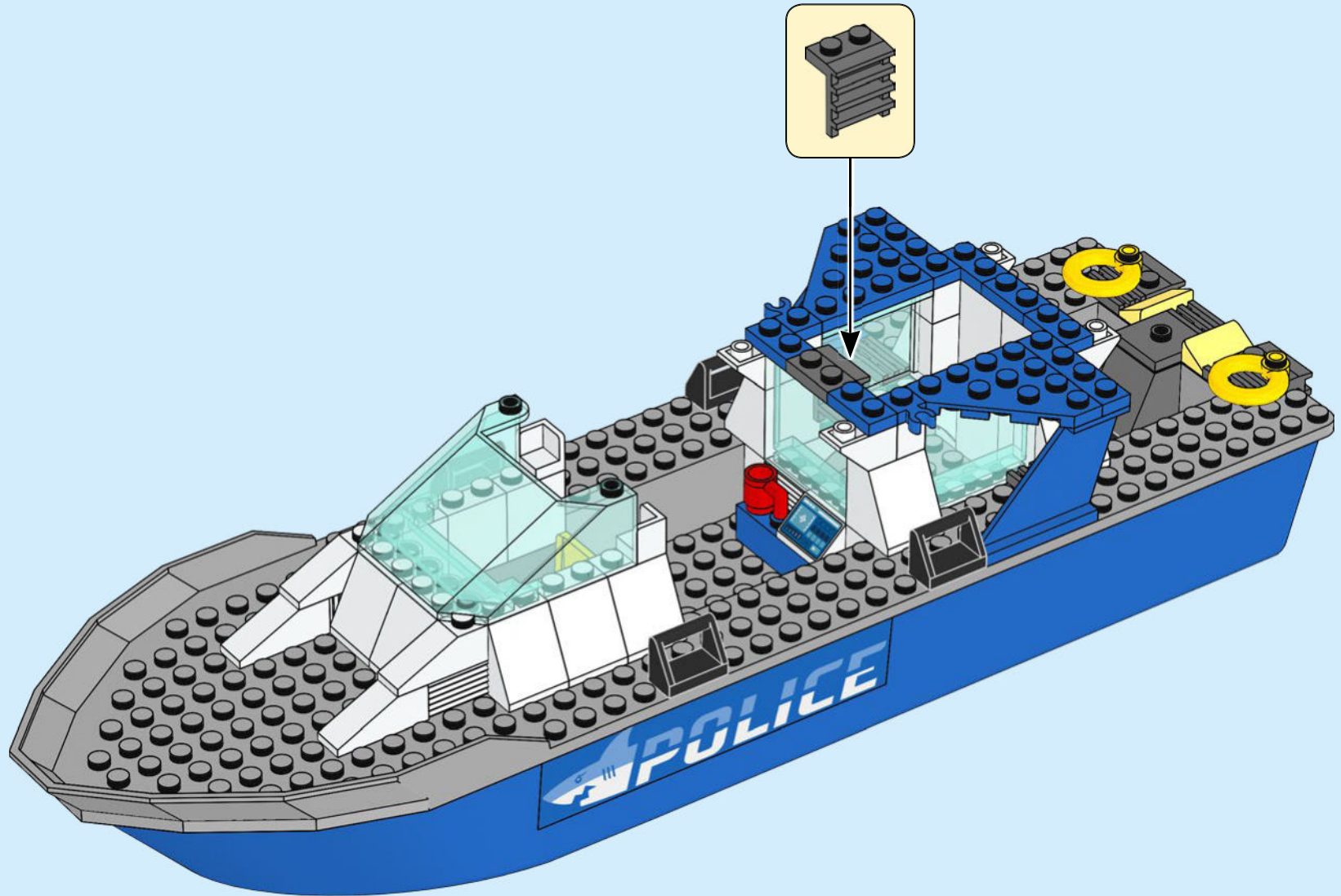

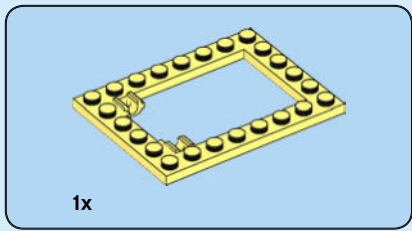

33

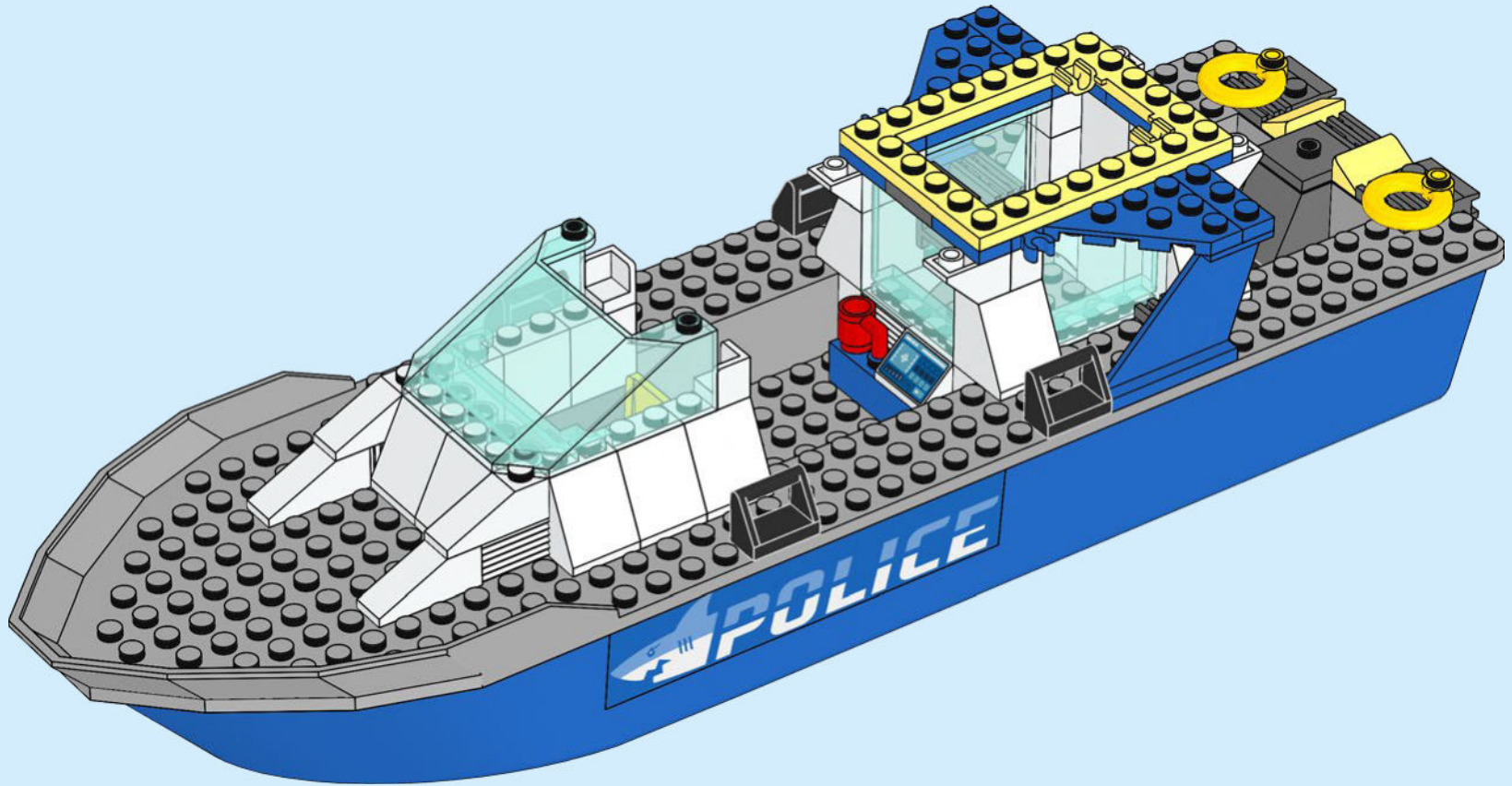



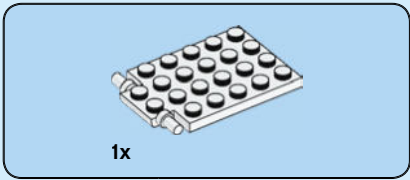

34

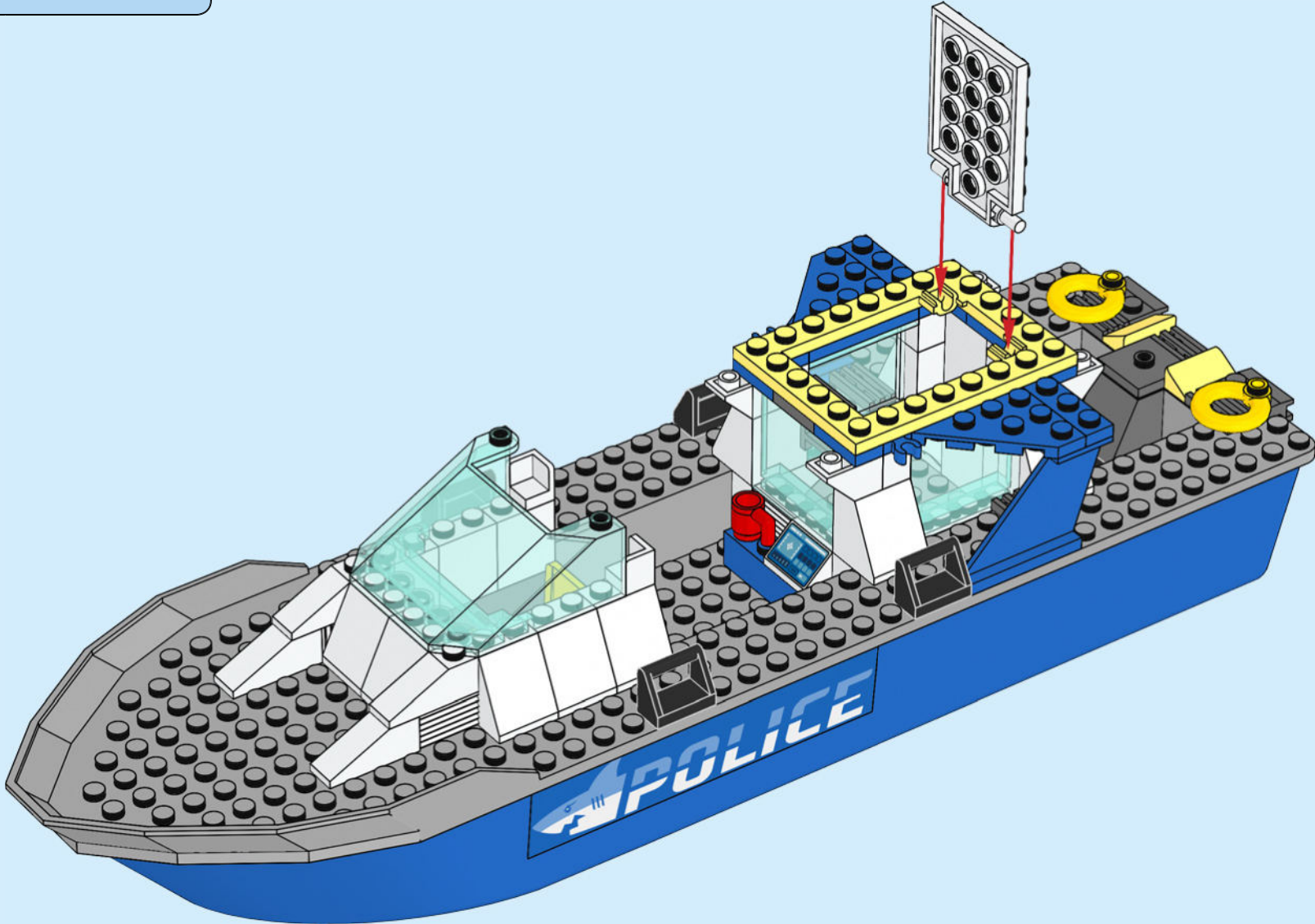



2x



2x

35

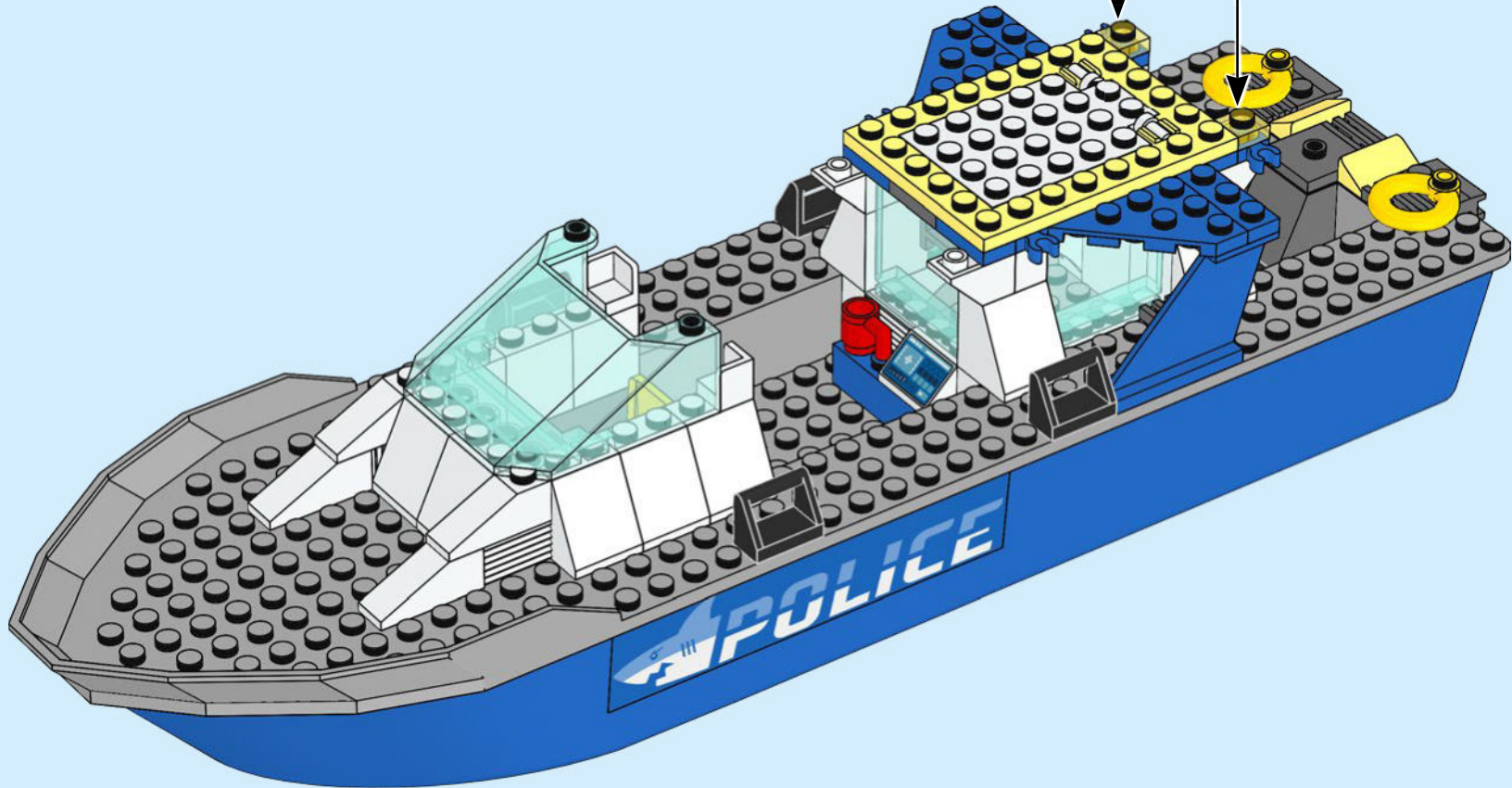
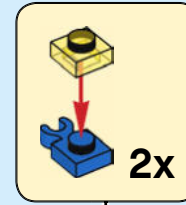



2x

36

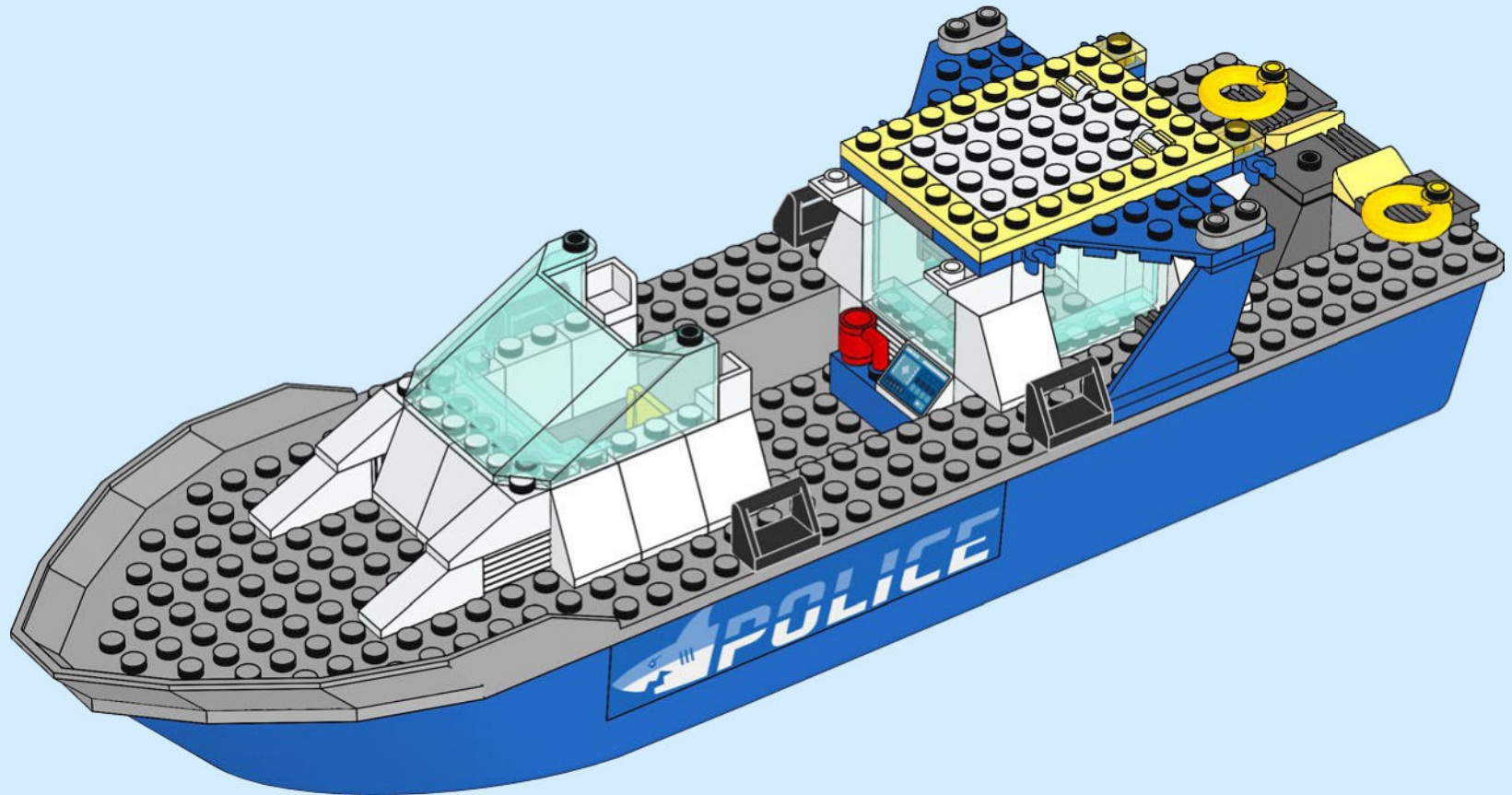



1x



1x

37

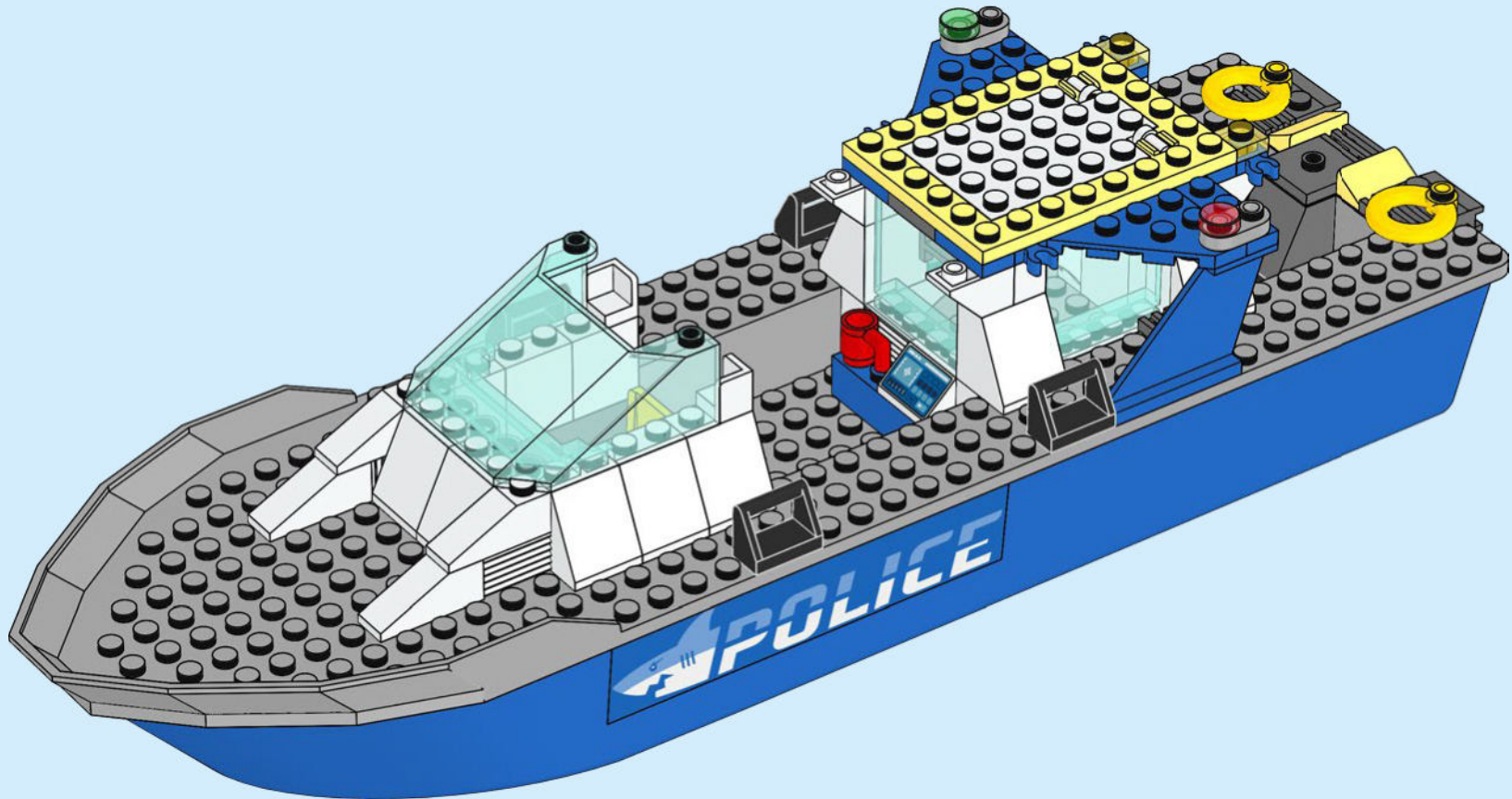



2x

38

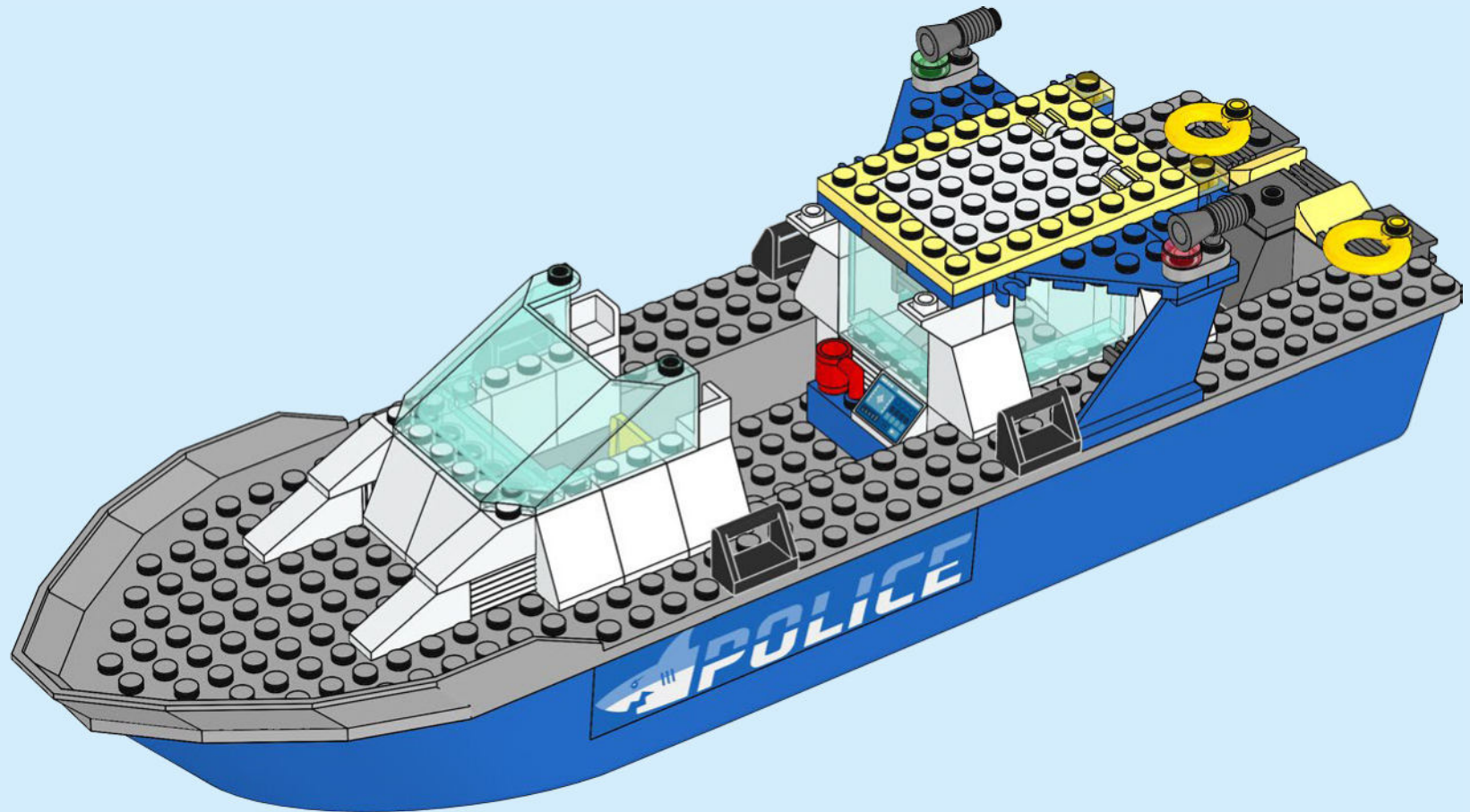

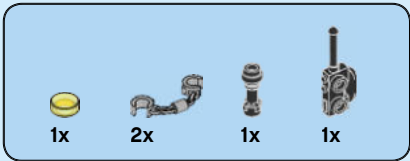

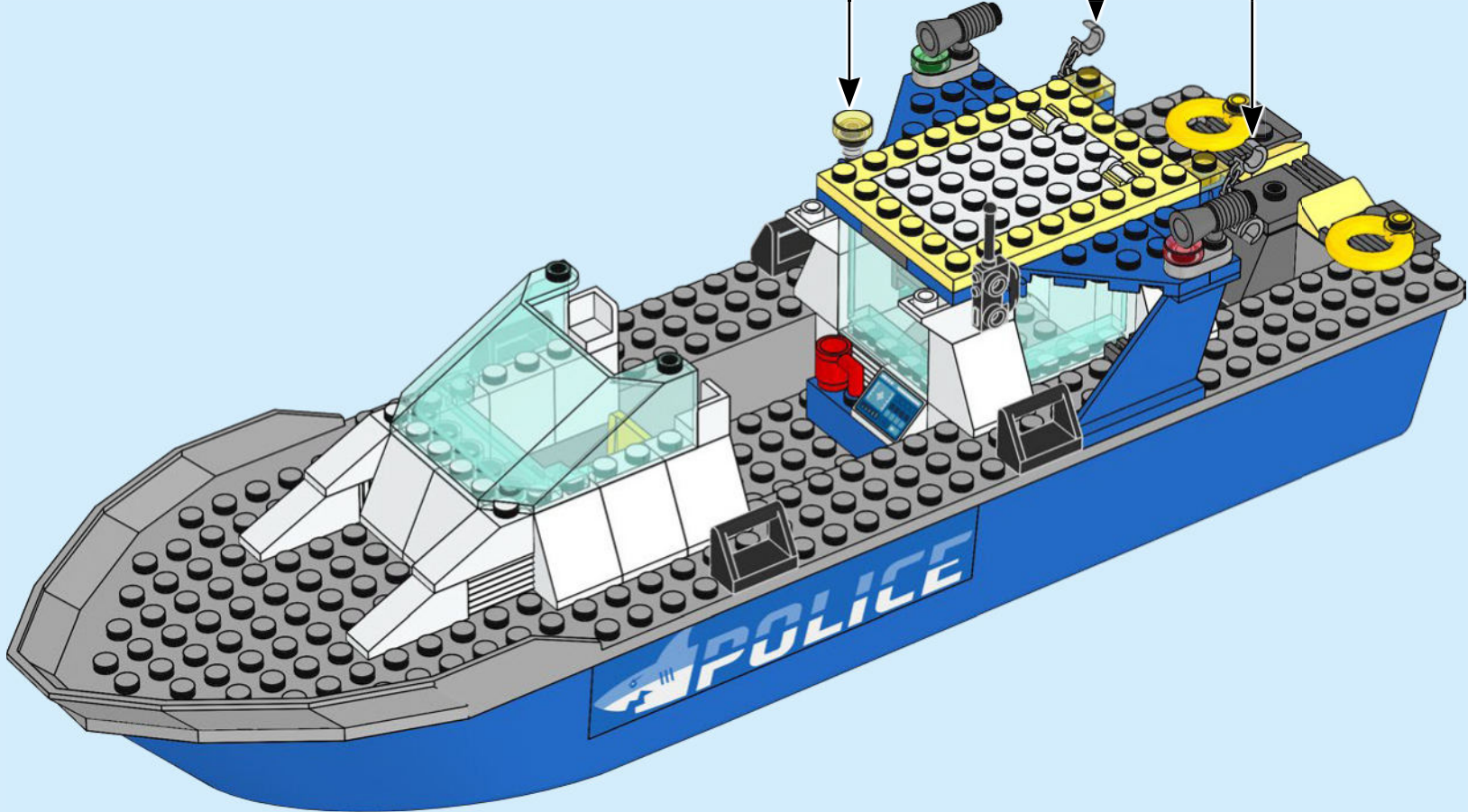

39

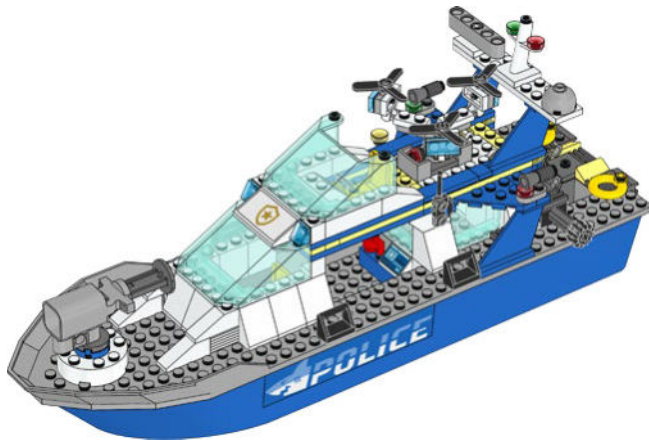



1x  2x 

40

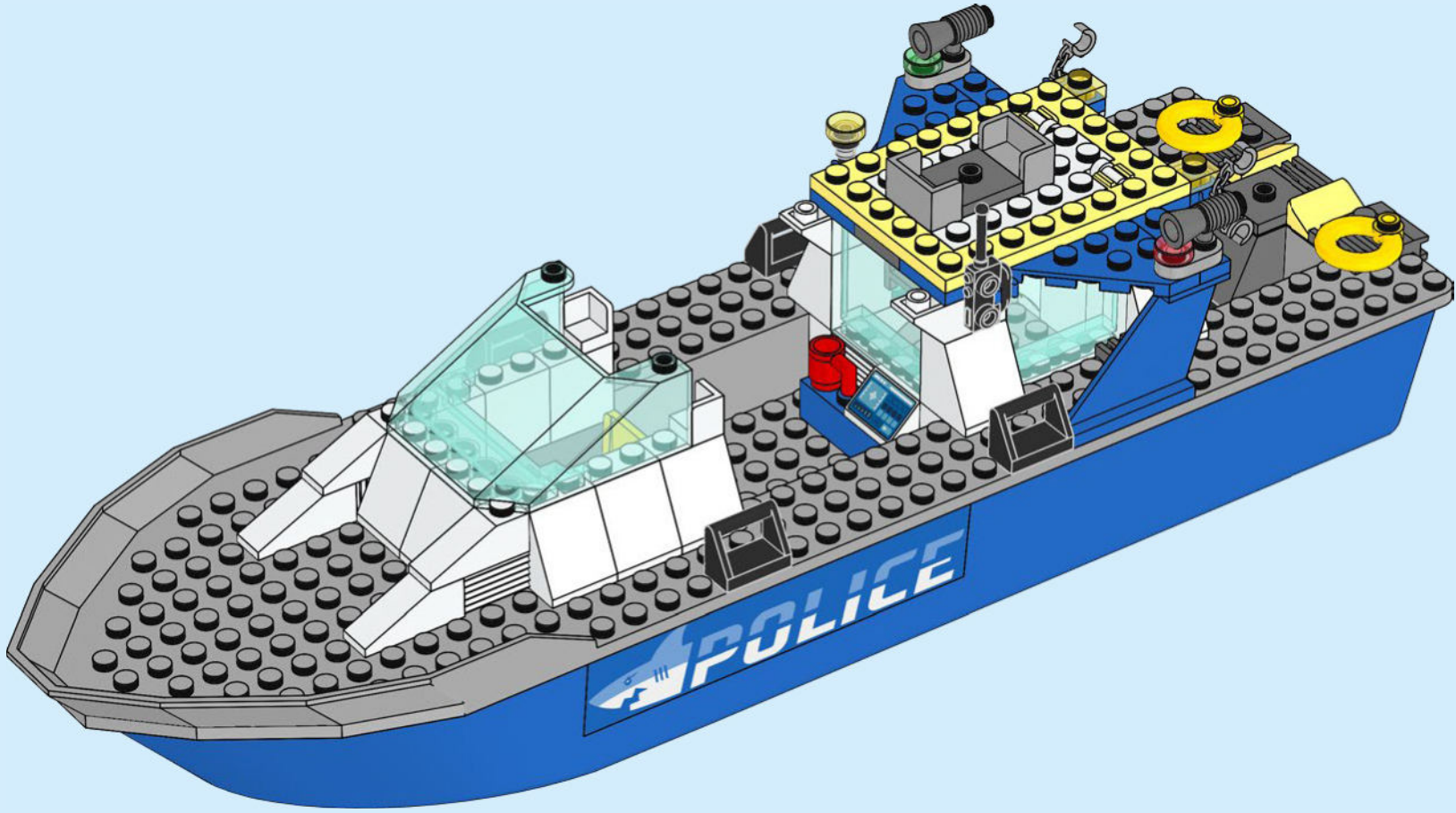



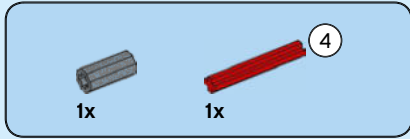
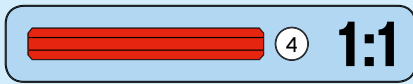
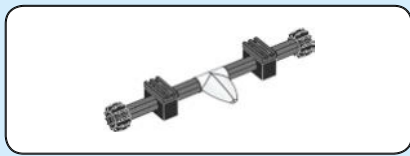

41

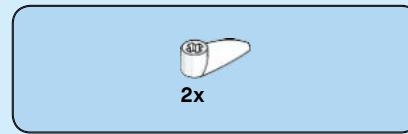
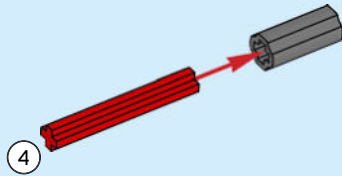

42

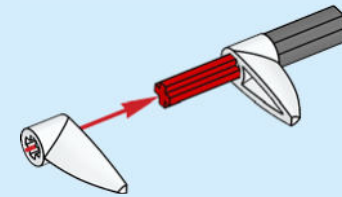



1x

43

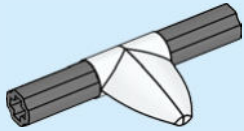

2x

44



3

1:1

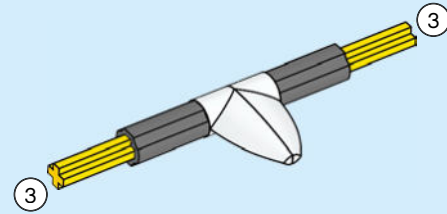

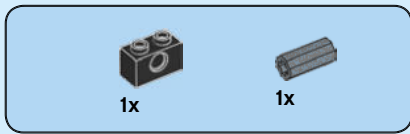

45

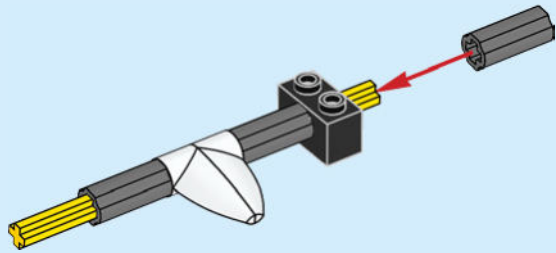

46

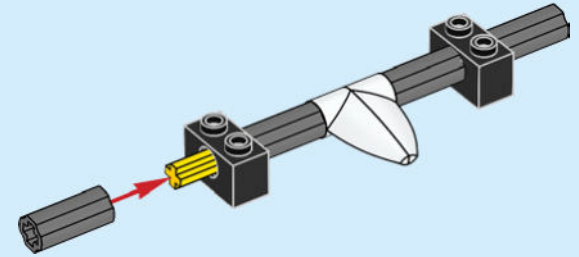



2x

47

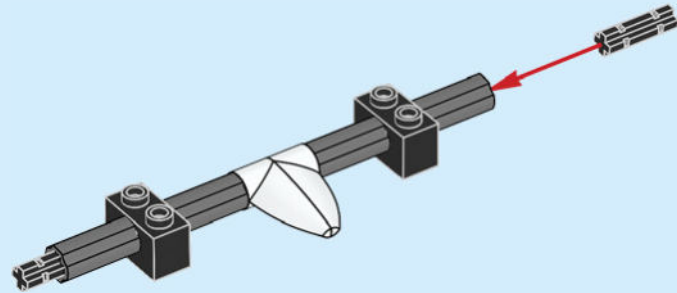

48

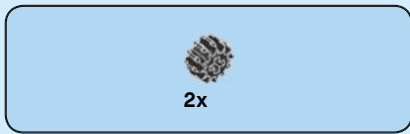

48

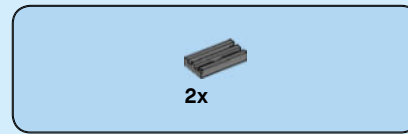
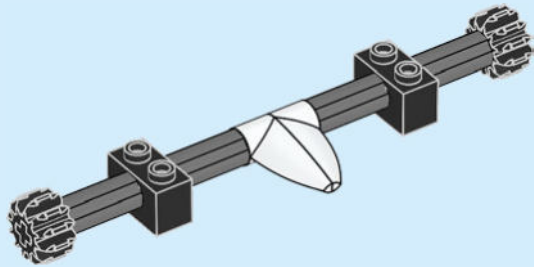

49

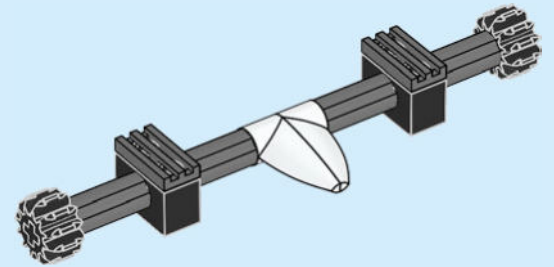

50

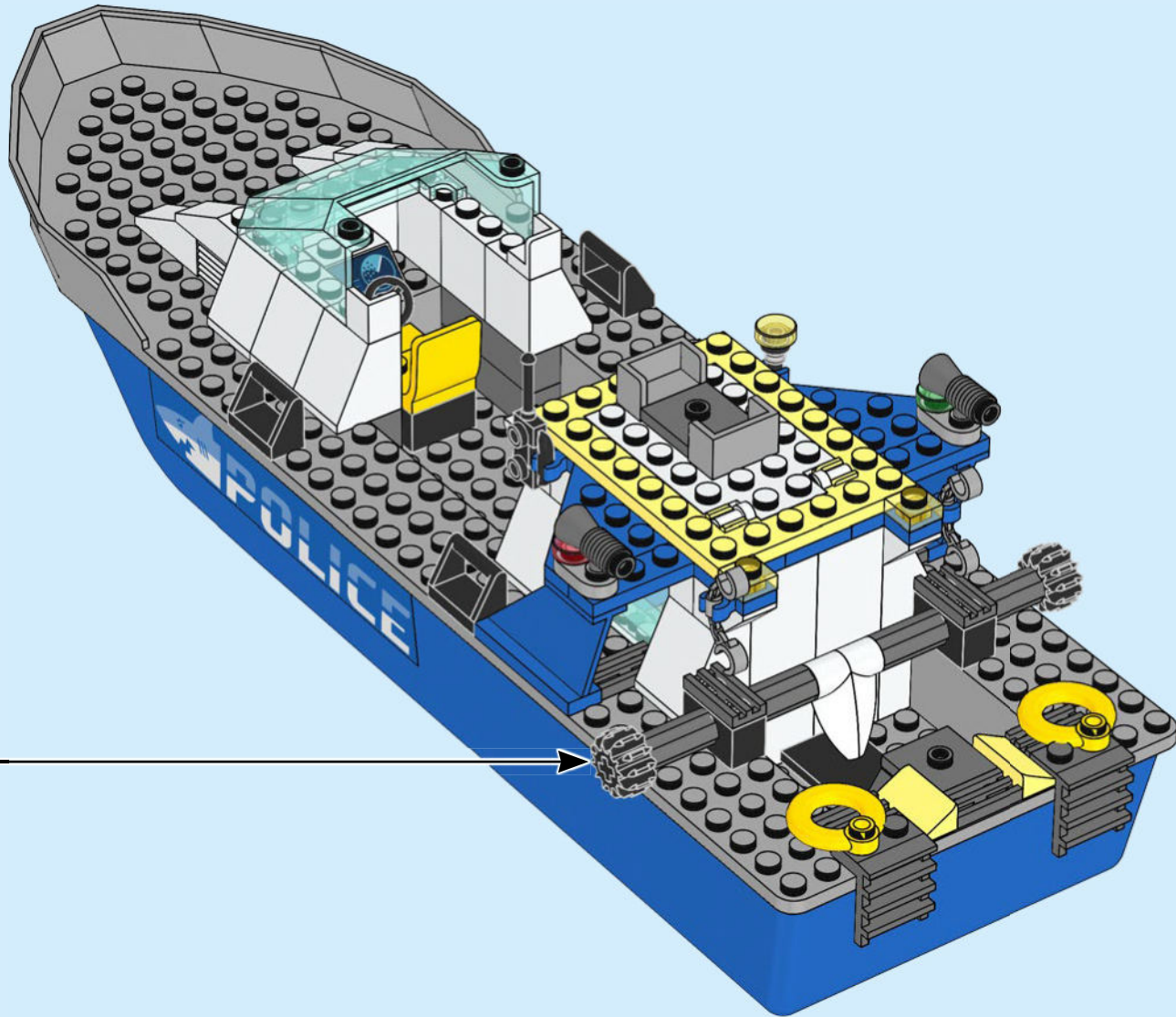

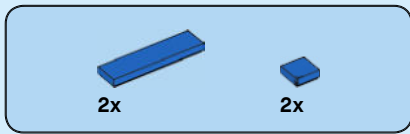

51

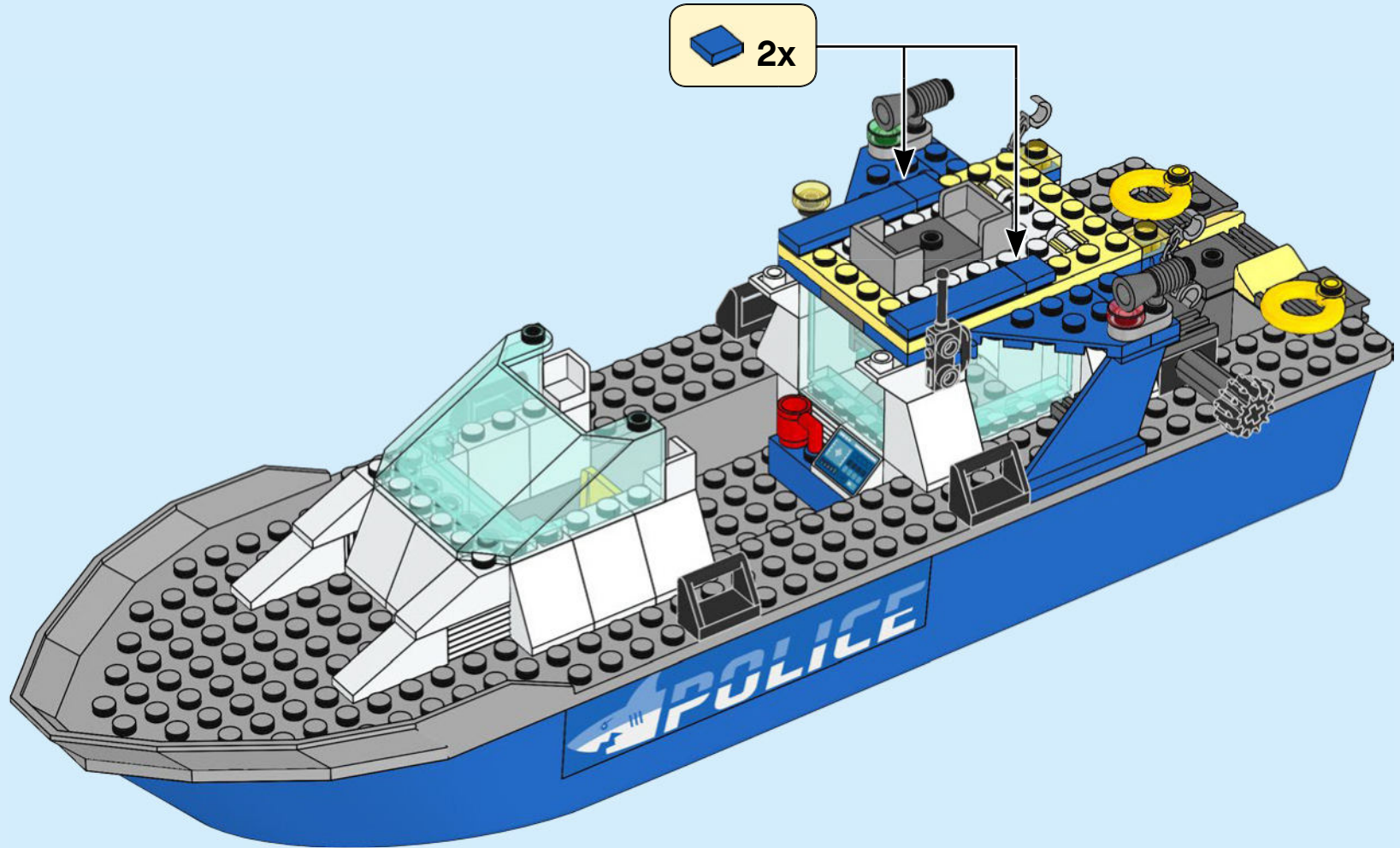

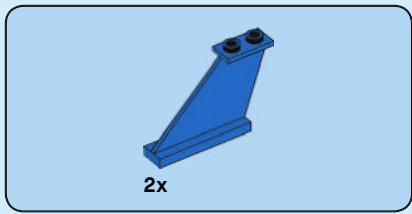

52

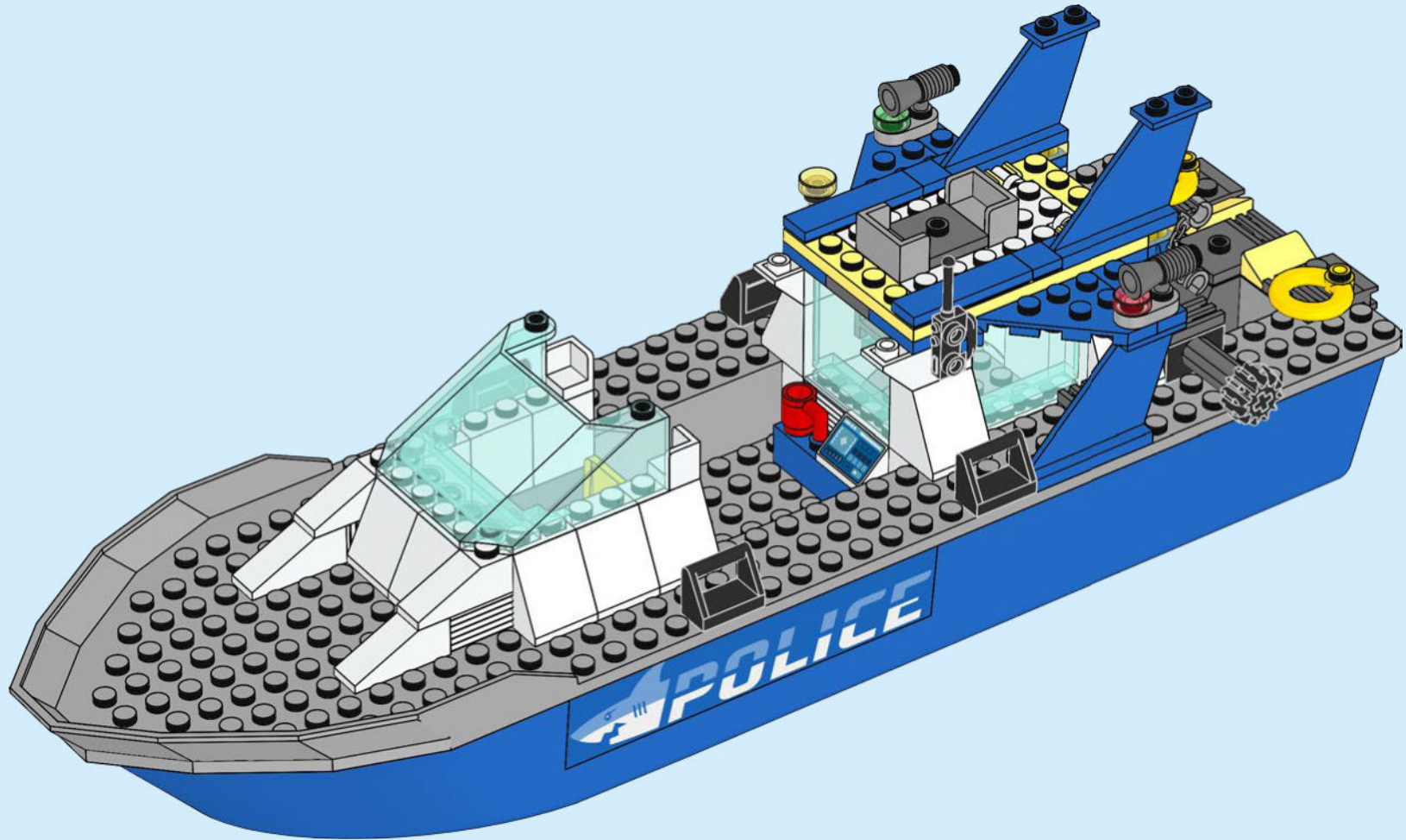



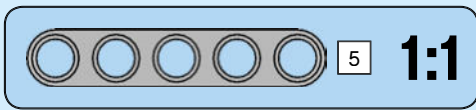
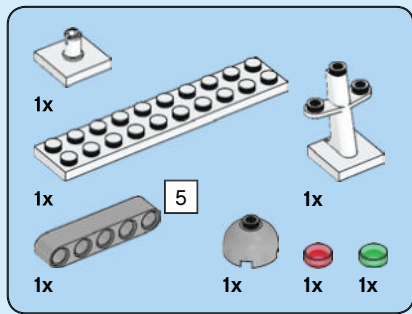

# 53

1

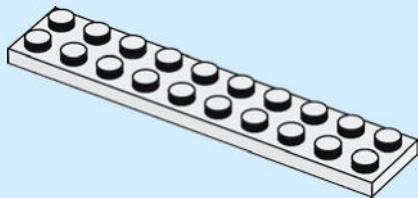

2

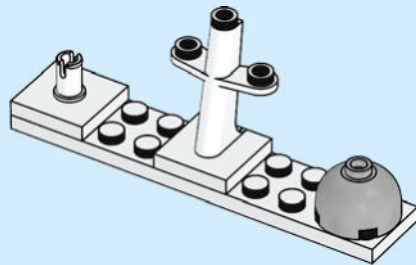

3

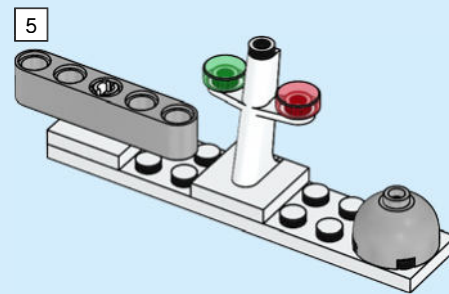

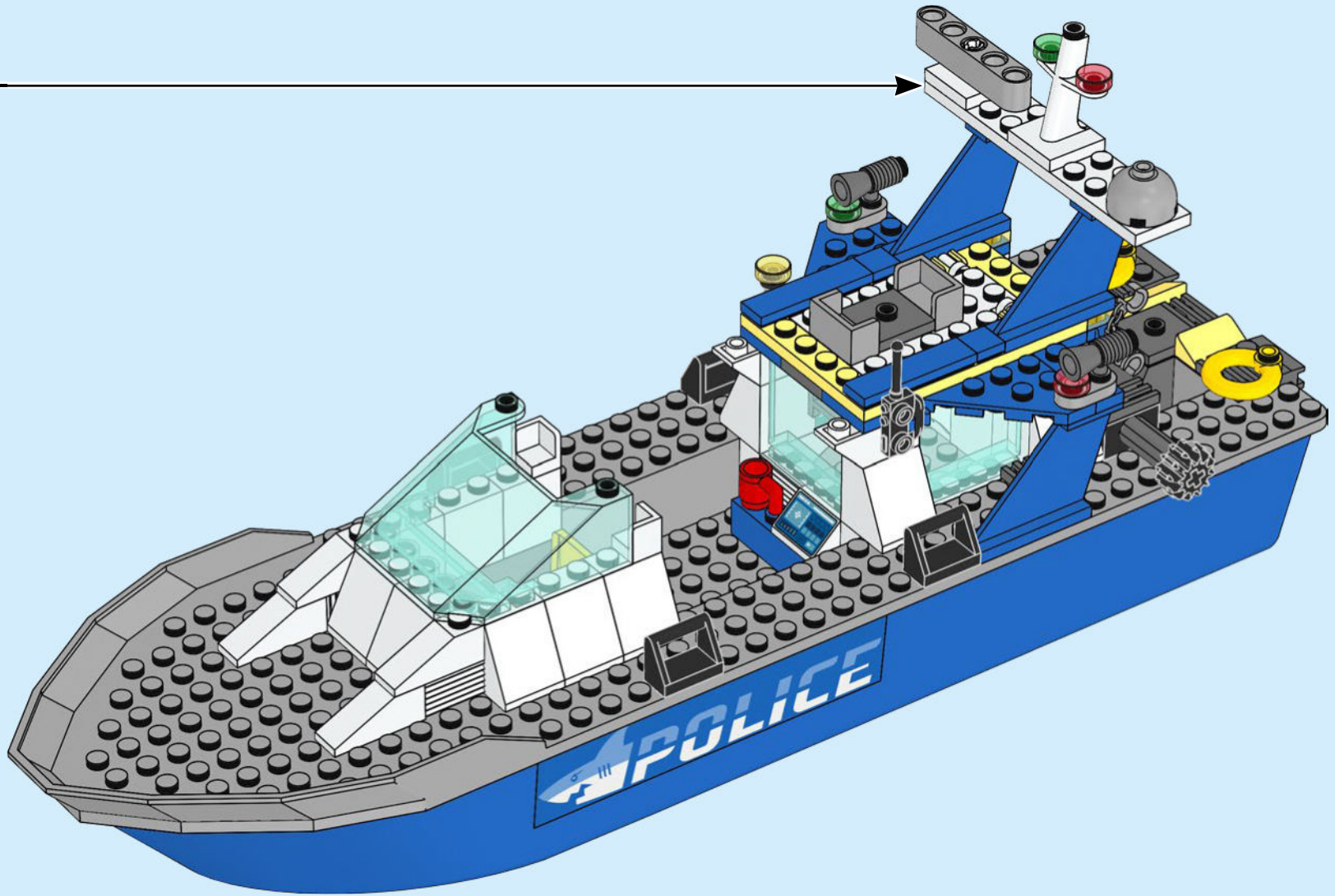

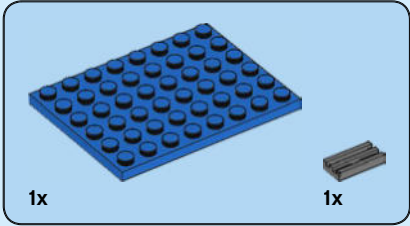

54

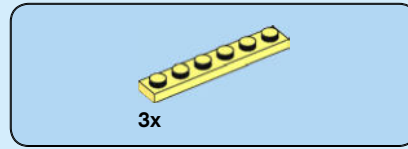
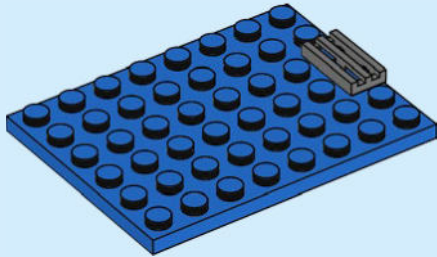

55

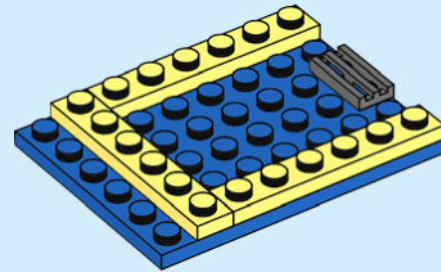

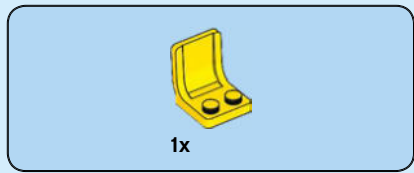

56

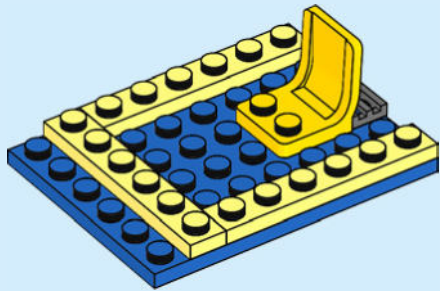

57

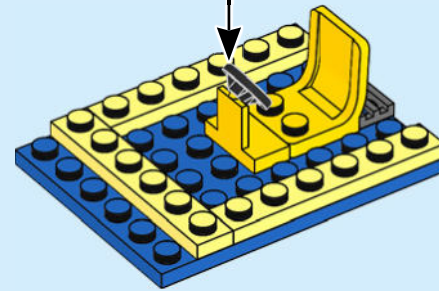

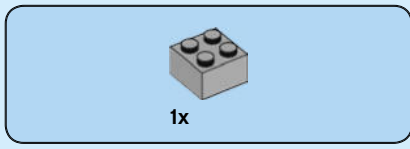

58

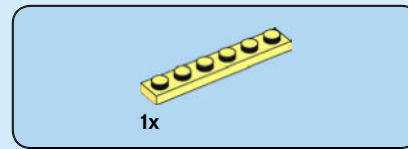
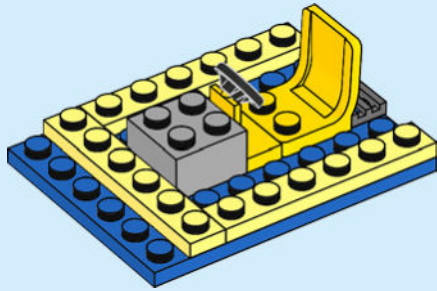

59

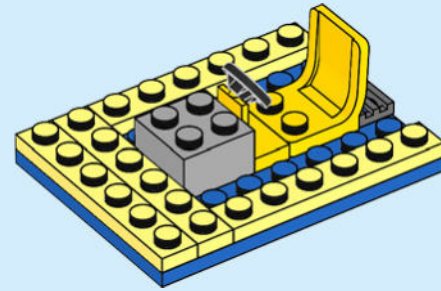

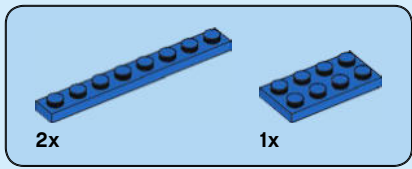

60

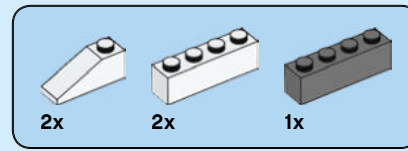
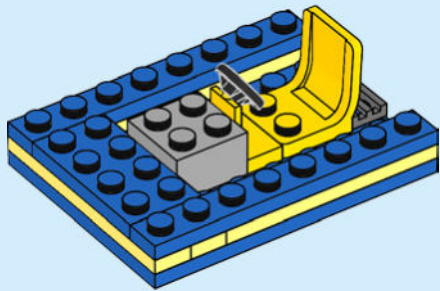

61

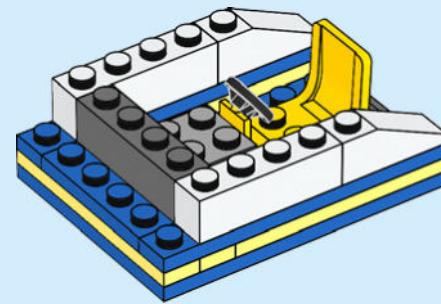



62

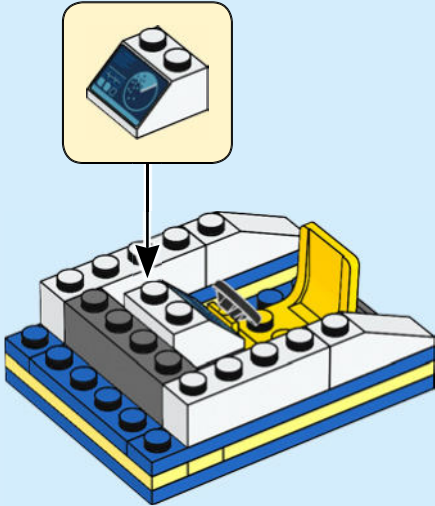

63

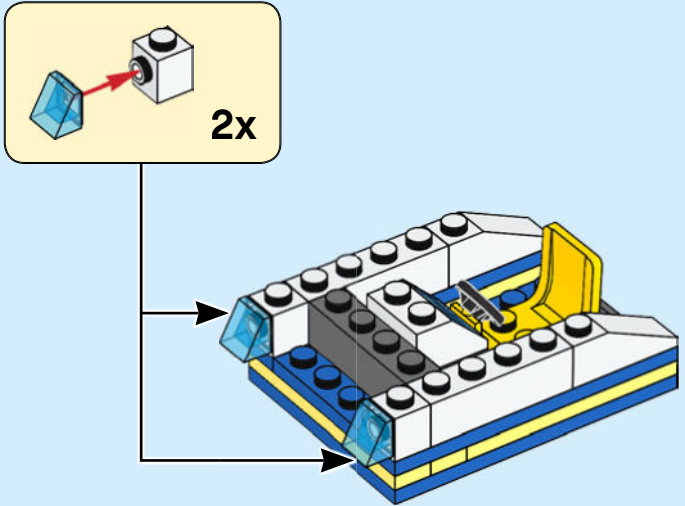

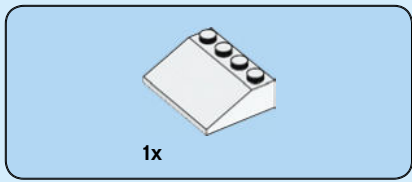

64

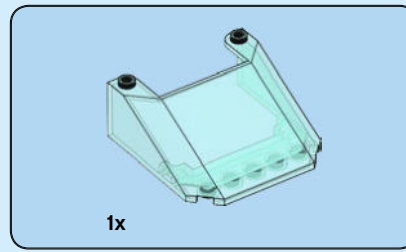
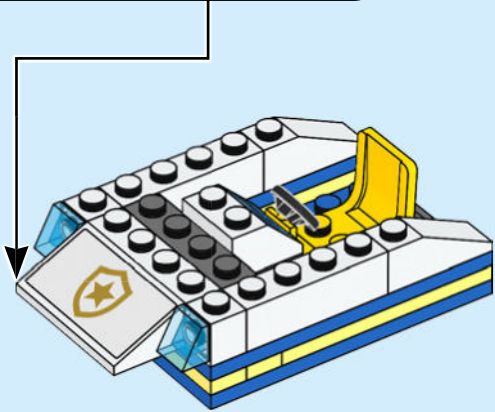
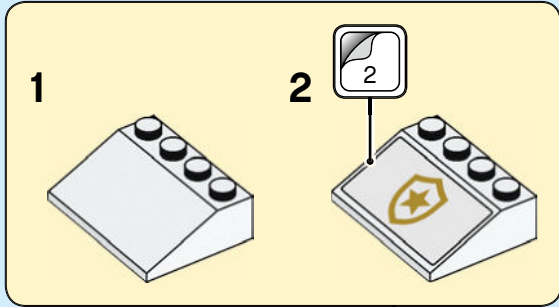

65

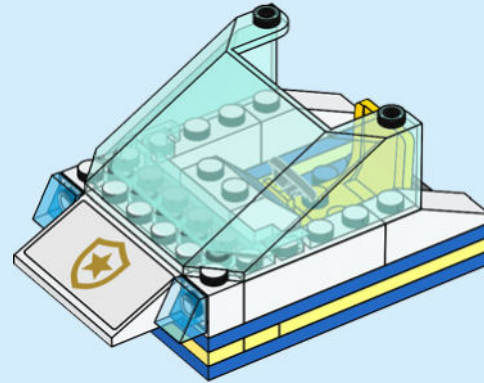



66

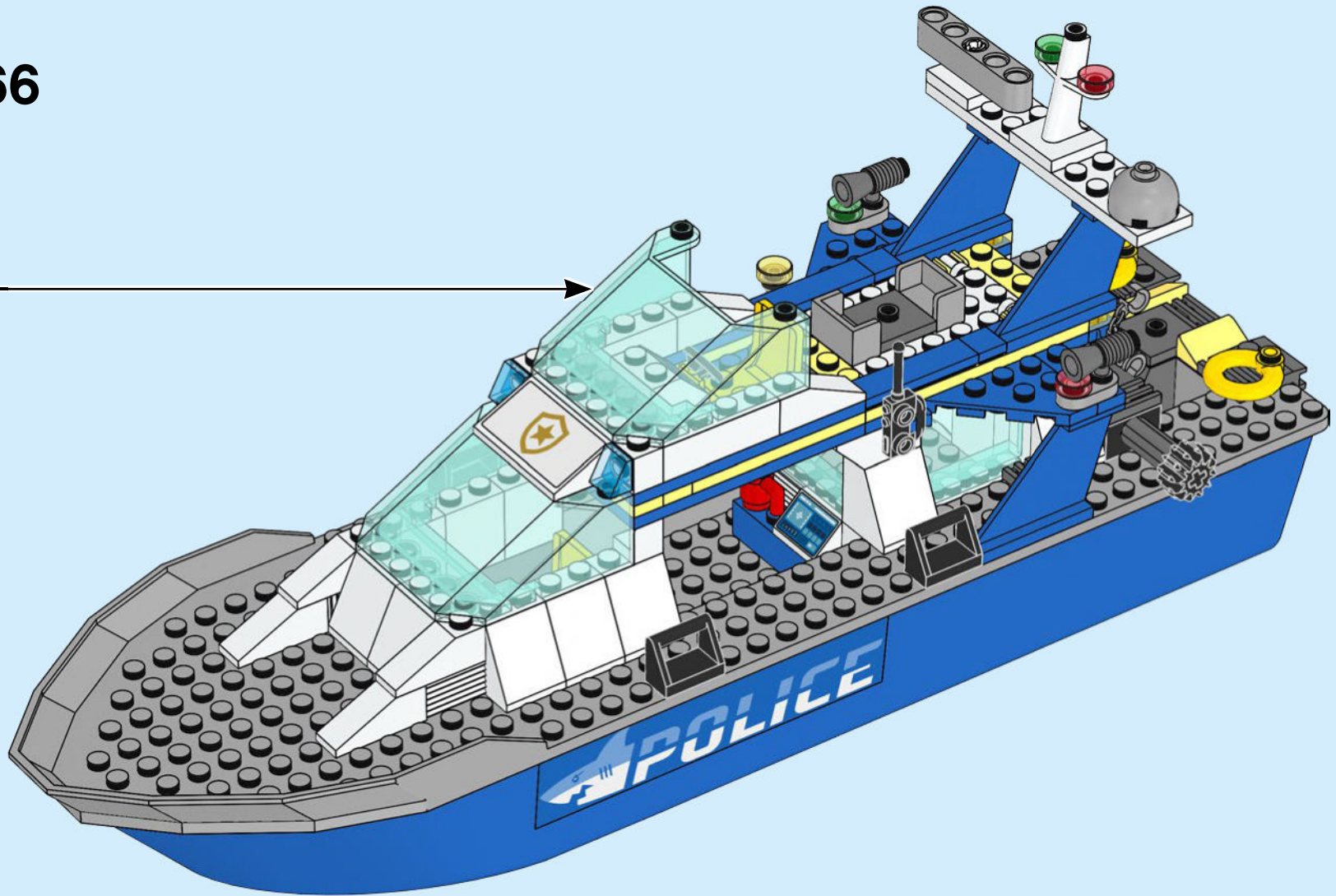

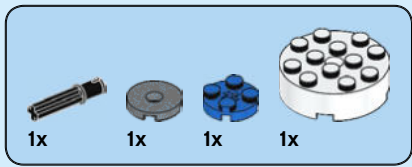

67

1



2

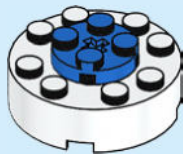

3

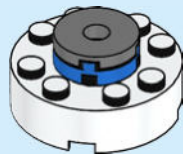

4

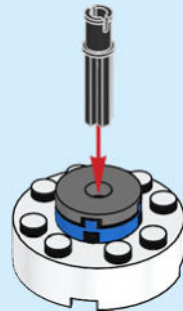



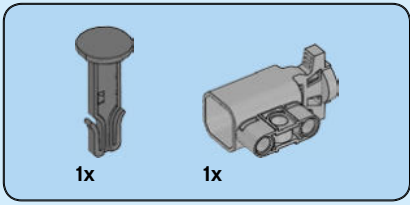

68

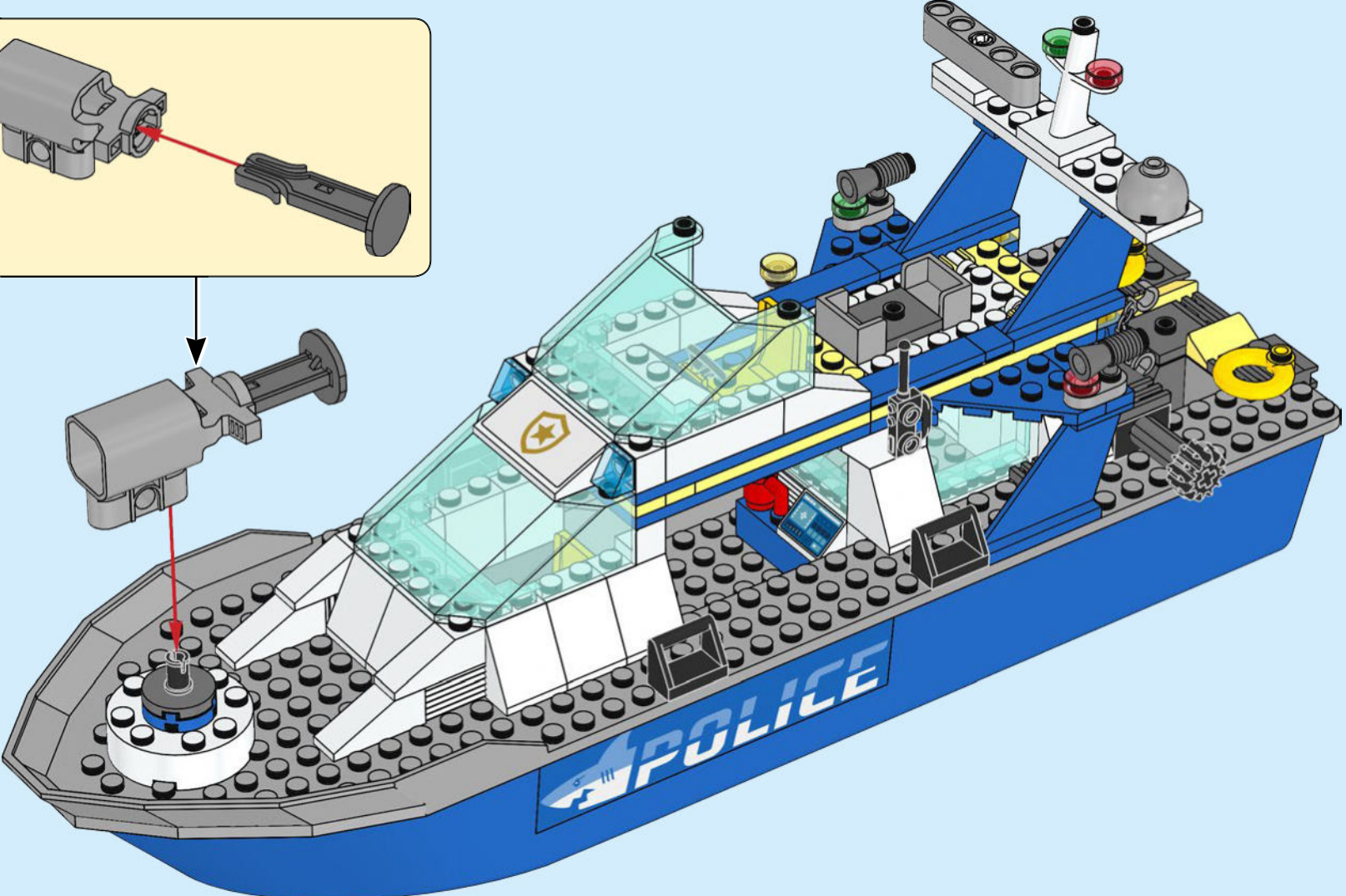
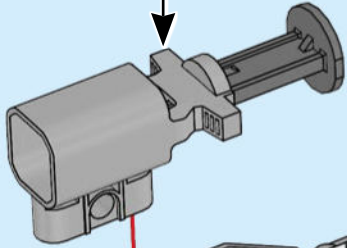
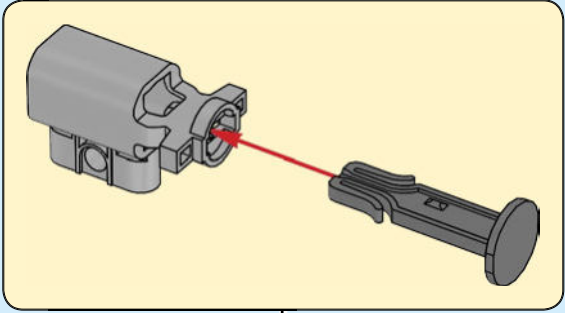



1x

69

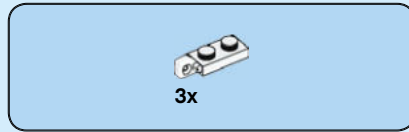
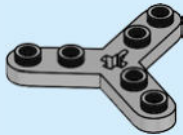

3x

70

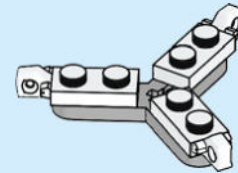



71

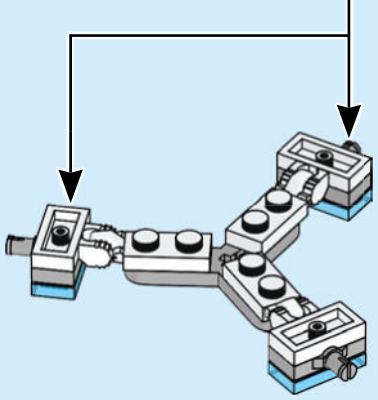
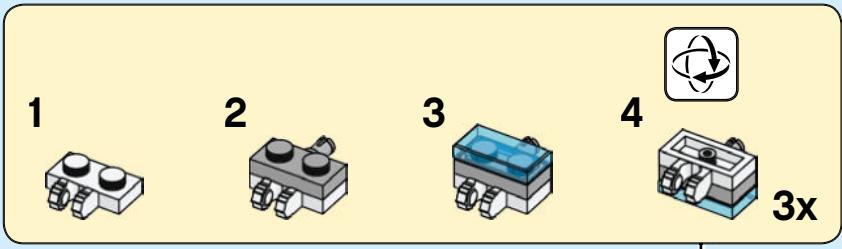

72

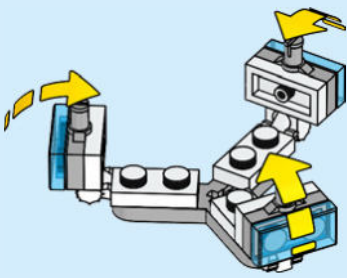



73

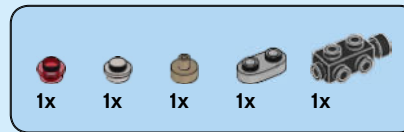
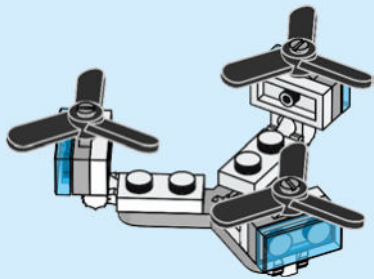

74

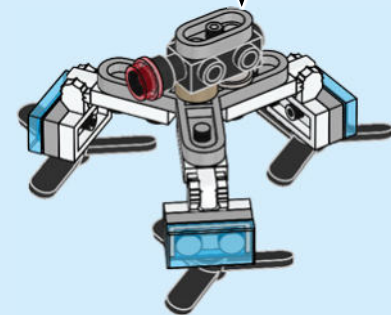
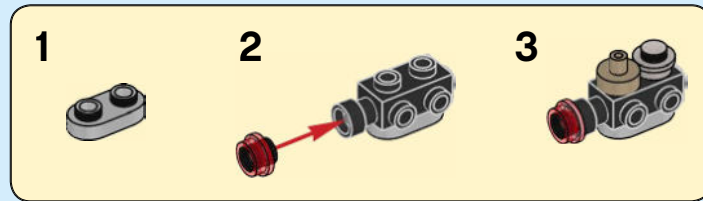

75

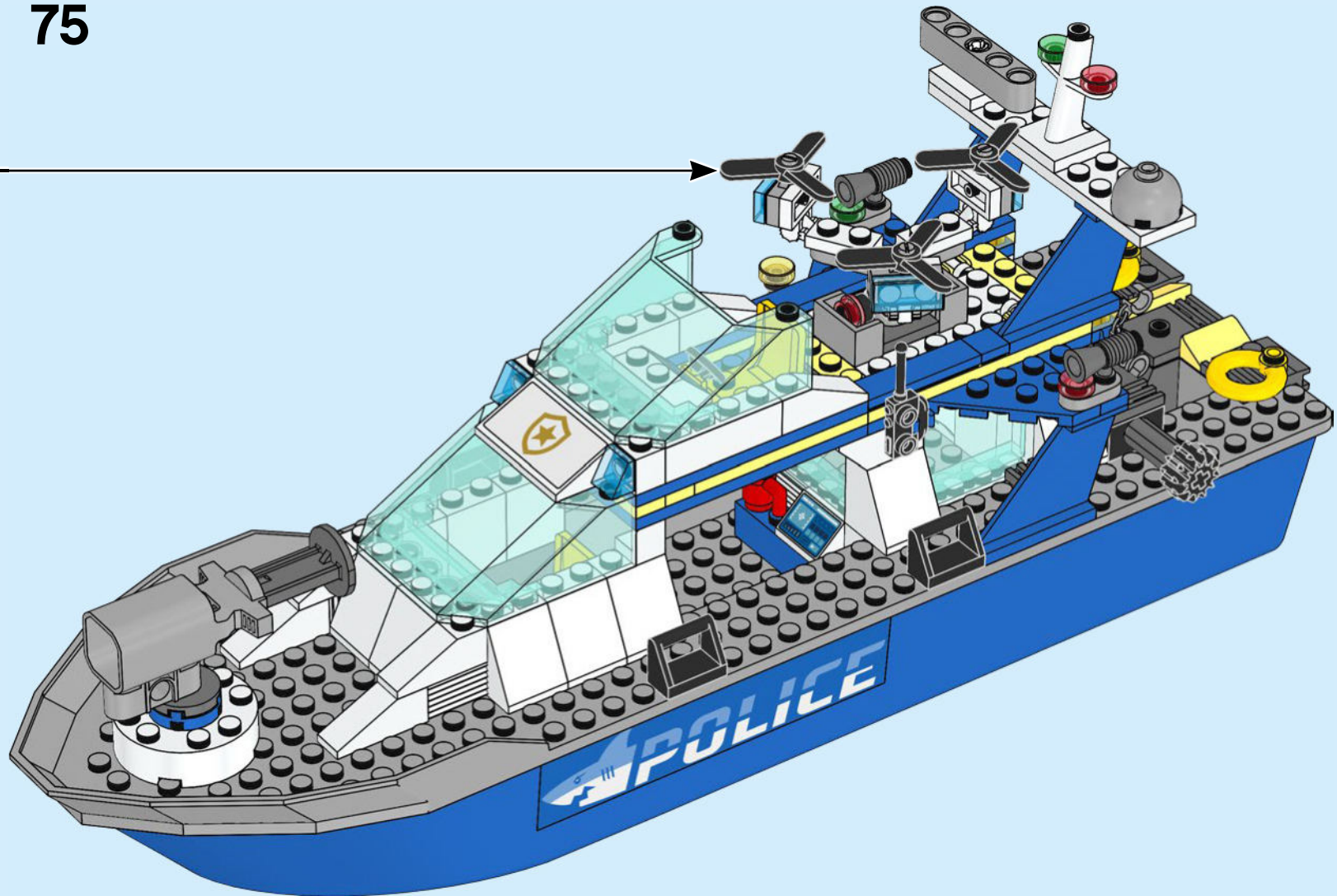



1

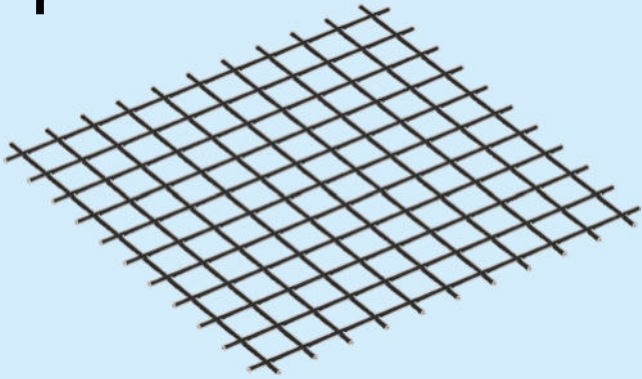

2

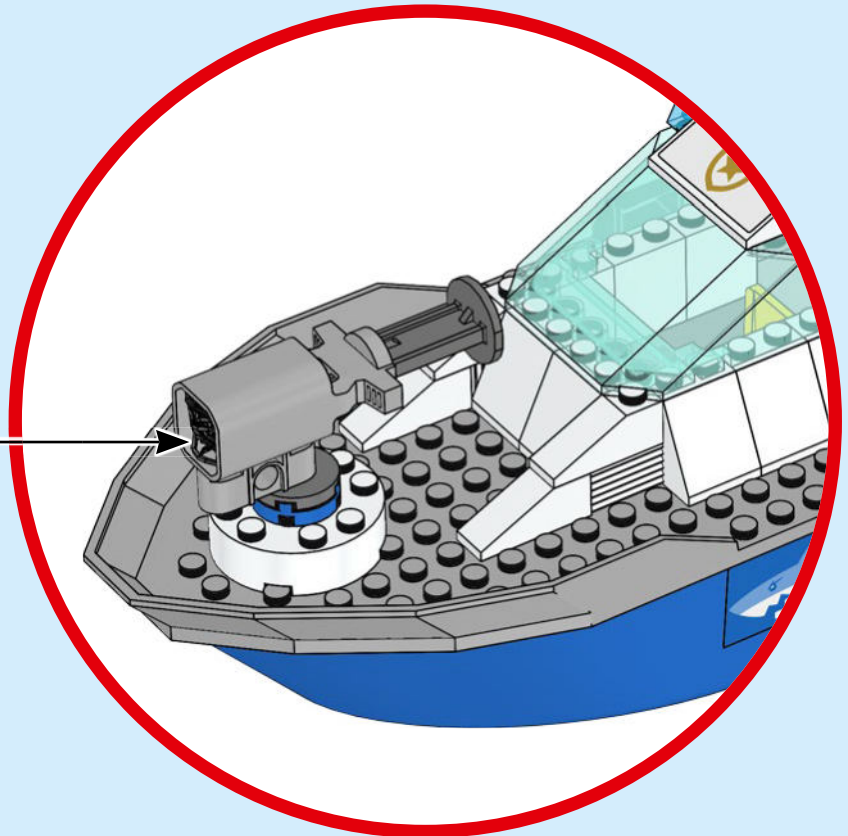
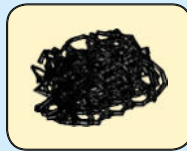
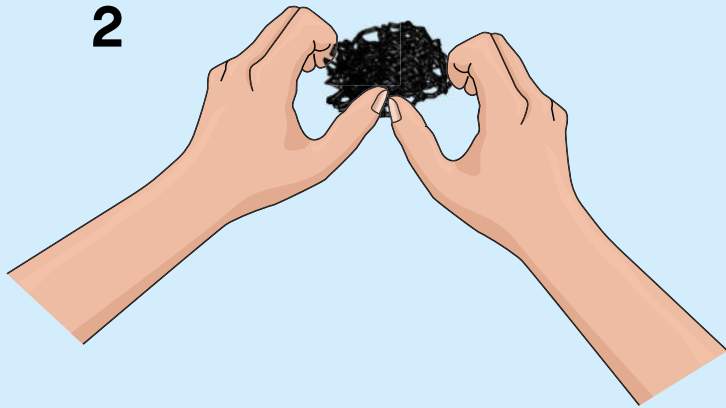

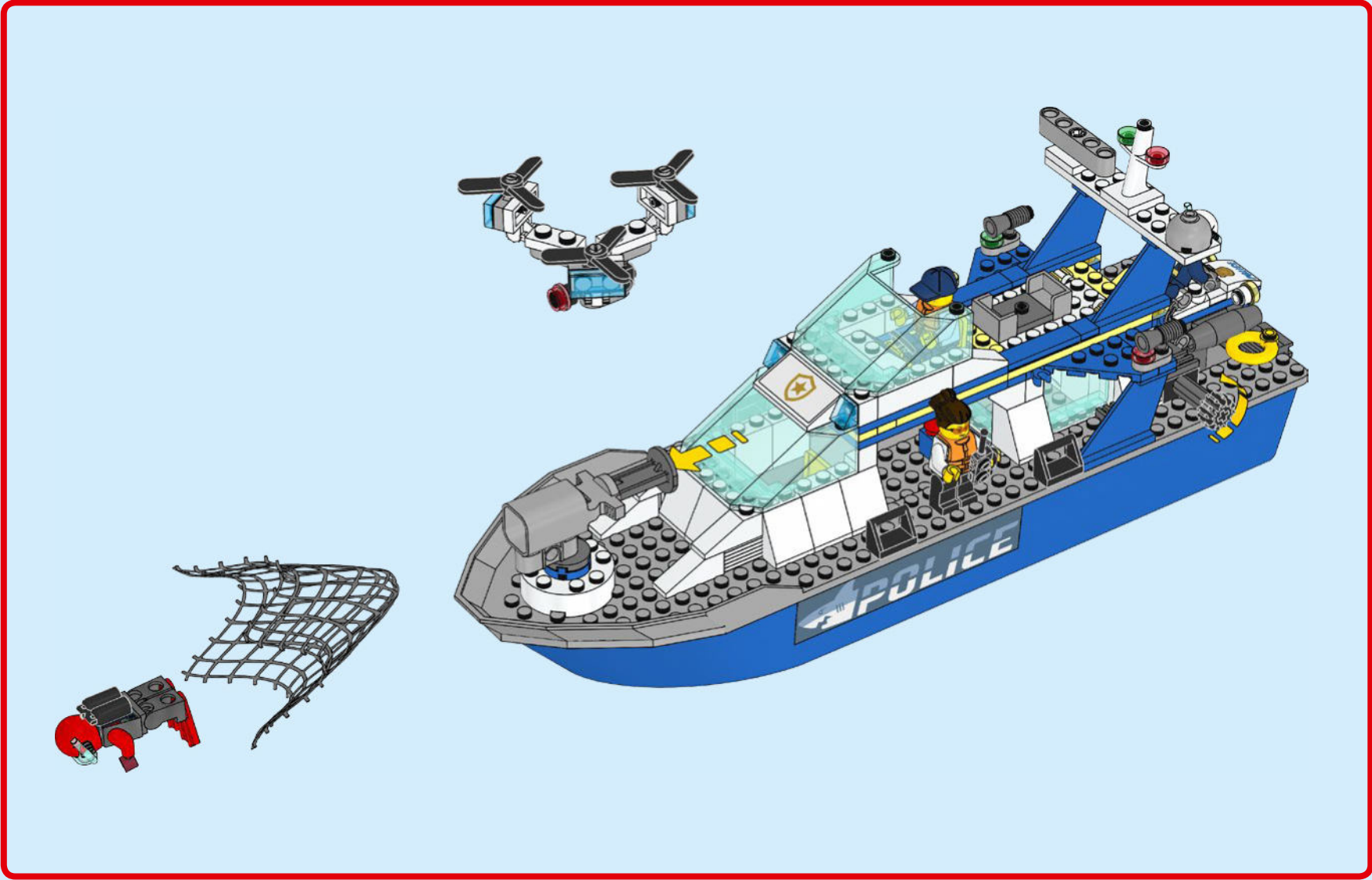

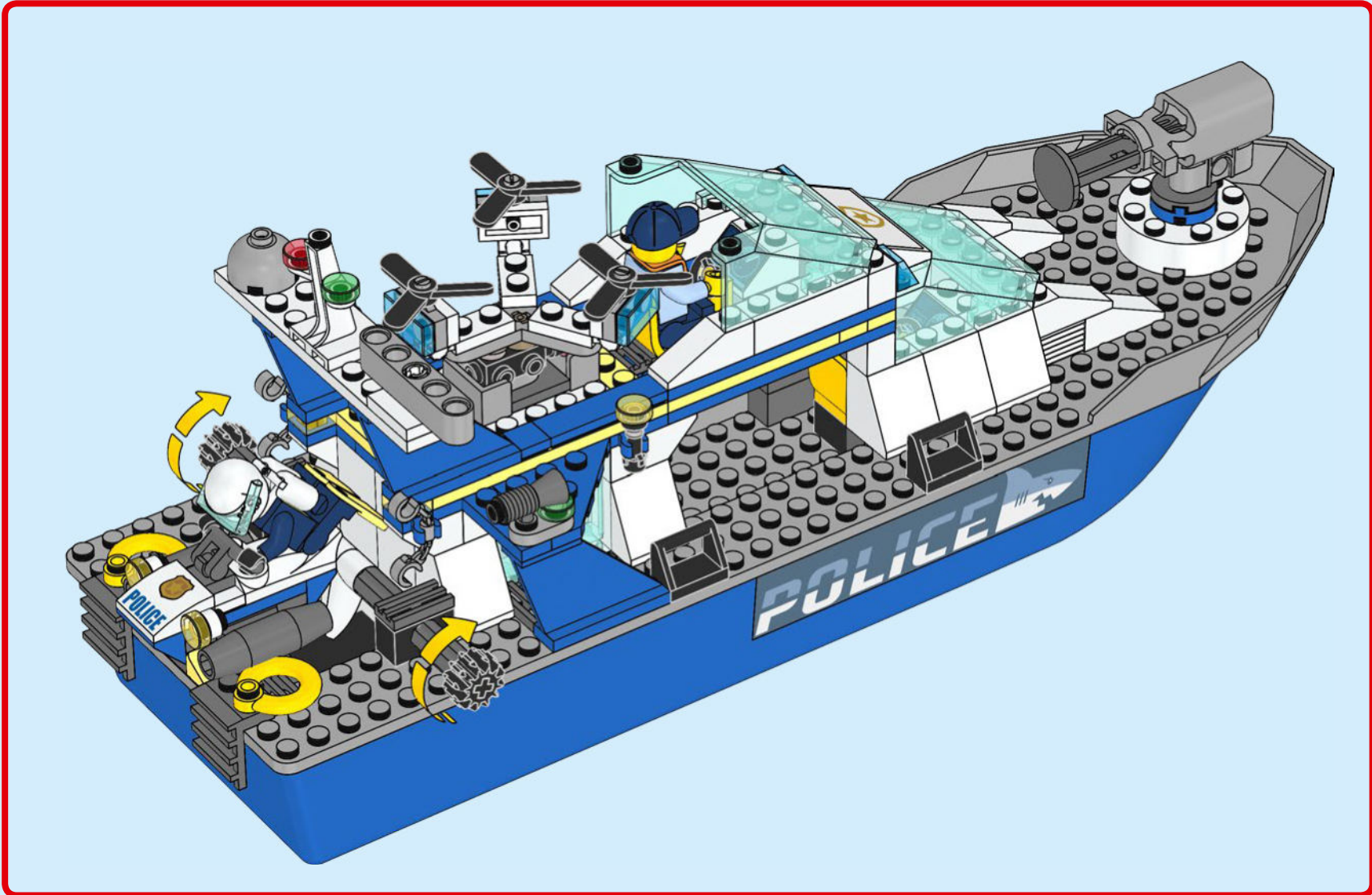







2x  
4558952



4x  
300501



2x  
623101



1x  
6268849



1x  
4298609



2x  
6281990



3x  
287701



4x  
366501



1x  
6051511



1x  
6174872



1x  
6329580



2x  
245401



1x  
329701



1x  
383201

74



12x  
4234525



2x  
6309297



1x  
6313138



1x  
6108866



6x  
428601



1x  
4610897



2x  
301001



1x  
4558956



1x  
4599044



2x  
6313647



2x  
6046379



1x  
6331852



3x  
6266201



2x  
6288218



3x  
6266219



2x  
4558886



2x  
4504379



1x  
389921



1x  
4298617



2x  
6172939



2x  
6347308



2x  
6089698



1x  
6331851



2x  
428621



1x  
6129995



2x  
6046379



1x  
6331852



2x  
4206330



4x  
6352221



1x  
403223



5x  
302323



2x  
243123



2x  
371023



2x  
302023



1x  
300123



4x  
6254953



2x  
6331843



1x  
6188643



2x  
346023



1x  
303623



1x  
6170545



1x  
6268852



2x  
4177431



2x  
4288212



1x  
6313481



1x  
6162892



2x  
302126



1x  
300226



1x  
4658977



1x  
4180469



1x  
6089119



1x  
4523339



1x  
6332270



2x  
4109810



1x  
6057397



1x  
9339



4x  
243226



4x  
370026



2x  
4184617



3x  
6170693



1x  
4163373



1x  
366026



1x  
6089119



1x  
4523339



1x  
6332270



2x  
4109810



1x  
9339



4x  
243226



4x  
370026



2x  
4184617



3x  
6170693



1x  
4163373



1x  
366026



1x  
6089119



1x  
4598897



1x  
6170545



1x  
6268852



2x  
4177431



2x  
4288212



1x  
6313481



1x  
6162892



2x  
302126



1x  
300226



1x  
4658977



1x  
4180469



1x  
6089119



1x  
4523339



1x  
6332270



2x  
4109810

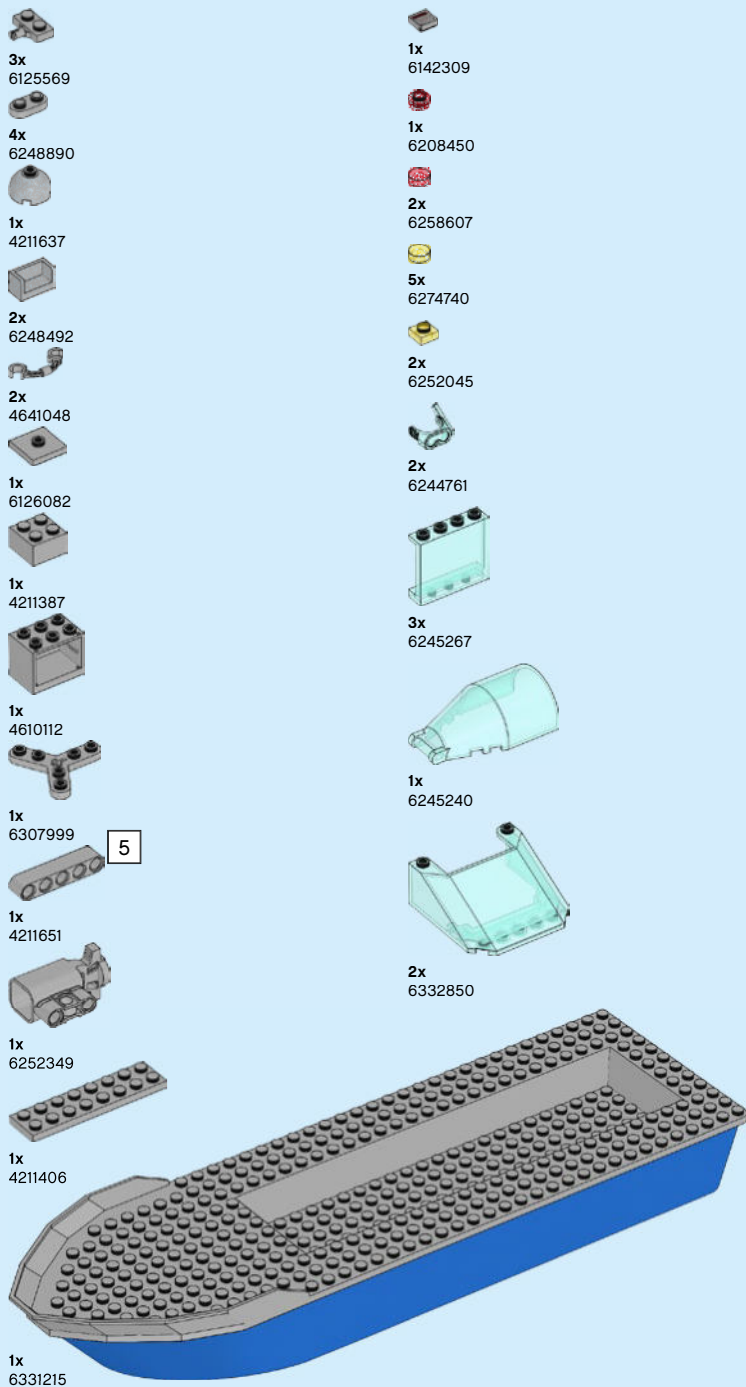

- 3x 6125569
- 4x 6248890
- 1x 4211637
- 2x 6248492
- 2x 4641048
- 1x 6126082
- 1x 4211387
- 1x 4610112
- 1x 6307999
- 1x 4211651
- 1x 6252349
- 1x 4211406
- 1x 6331215

- 1x 6142309
- 1x 6208450
- 2x 6258607
- 5x 6274740
- 2x 6252045
- 2x 6244761
- 3x 6245267

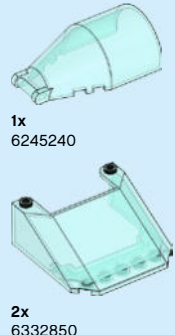

- 1x 6245240
- 2x 6332850

- 2x 6274742
- 1x 6288002
- 1x 6301547
- 1x 6021844
- 1x 6211710
- 1x 6328351
- 2x 9553
- 2x 4527354
- 2x 6130007
- 2x 407924
- 2x 6296510
- 2x 6331847
- 4x 6211356
- 1x 6331845

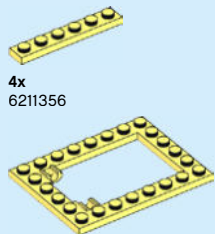

- 1x 6344022
- 2x 4210698
- 1x 6055313
- 1x 6217847
- 4x 4516546
- 1x 4222693
- 3x 4211063
- 1x 6197015
- 1x 6107827
- 2x 6107171
- 5x 4211103
- 1x 6044722
- 1x 6258887

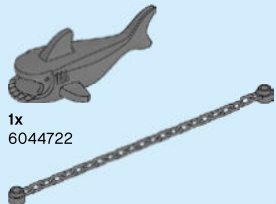

- 8x 4210631
- 1x 4210811
- 3x 6285244
- 1x 4261908
- 2x 6126083
- 1x 4234534
- 2x 6231925
- 1x 6056241
- 2x 4162916
- 1x 6236969

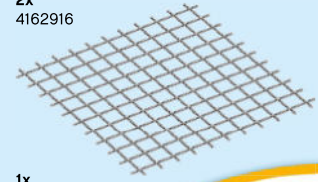

- 1x 4633691
- 1x 6158322
- 1x 6301980
- 4x 6207933
- 3x 6300320
- 2x 6245256
- 3x 6251289
- 1x 6332161
- 1x 6302503
- 1x 6172536
- 1x 6332017



Customer Service  
 Kundenservice  
 Service Consommateurs  
 Servicio Al Consumidor  
 LEGO.com/service or dial



: 00800 5346 5555  
 : 1-800-422-5346

# WIN

GO TO [WWW.LEGO.COM/PRODUCTFEEDBACK](http://WWW.LEGO.COM/PRODUCTFEEDBACK) AND  
GIVE US YOUR SHORT **FEEDBACK** ABOUT THIS  
LEGO® SET FOR A CHANCE TO WIN  
A COOL LEGO PRIZE.

Terms & Conditions apply



## [LEGO.com/productfeedback](http://LEGO.com/productfeedback)

### GEWINNE

Erzähle uns auf  
[www.LEGO.com/productfeedback](http://www.LEGO.com/productfeedback)

etwas über die Erfahrungen, die  
du mit diesem LEGO® Set gemacht  
hast, und sichere dir die Chance  
auf einen coolen LEGO Preis!

Es gelten die  
Teilnahmebedingungen

### GAGNE

Rends-toi sur  
[www.LEGO.com/productfeedback](http://www.LEGO.com/productfeedback)

et donne-nous quelques com-  
mentaires sur ce produit LEGO®  
pour avoir une chance de gagner  
un prix LEGO !

Voir Conditions Générales

### GANAN

Visita  
[www.LEGO.com/productfeedback](http://www.LEGO.com/productfeedback)

y envíanos tu opinión acerca de  
este set LEGO®. ¡Participarás en el  
sorteo de un premio LEGO!

Términos y Condiciones aplicables

### 获取奖品

登录  
[www.LEGO.com/productfeedback](http://www.LEGO.com/productfeedback)

给出关于此乐高®套装的简短反馈，  
就有机会获得炫酷乐高奖品

《条款及条件》适用

### 경품 당첨 기회

[www.LEGO.com/productfeedback](http://www.LEGO.com/productfeedback)

페이지로 이동하여 이 레고® 세트에  
대한 간략한 피드백을 보내 주시고  
멋진 레고 경품을 탈 수 있는 기회도  
잡으십시오

약관 적용

### ЗАПОЛНИ АНКЕТУ И ПОЛУЧИ ПРИЗ

Перейди по ссылке  
[www.LEGO.com/productfeedback](http://www.LEGO.com/productfeedback)

ответь всего на несколько во-  
просов об этом наборе LEGO®,  
и у тебя появится шанс выиграть  
замечательный приз от компании  
LEGO.

Применяются Условия и правила  
участия